



- J-585™

- J-575™

J-500™ COLLECTION
OWNER'S MANUAL
2530-278G Rev A

Attention New Spa Owner!

Congratulations on the purchase of your new Jacuzzi® spa! The following is a list of automated functions performed by your spa. These functions are listed below in an attempt to suppress any operational concerns you may have during the first 24 hours of ownership! Also listed below are important maintenance recommendations you should observe on a regular basis to protect your new investment.

Maintain Healthy Spa Water

Always maintain your spa's water chemistry within the following parameters:

	With CLEARRAY®	Without CLEARRAY®
pH	7.4-7.6	7.4-7.6
Free chlorine	no less than 1.0 ppm	3.0-4.0 ppm
Free bromine	no less than 2.0 ppm	2.0-4.0 ppm
Total Alkalinity	100-150 ppm	100-150 ppm
Calcium Hardness	150-250 ppm	150-250 ppm

IMPORTANT: CLEARRAY® Water Purification System is factory installed. If the CLEARRAY® system is altered or is not operating efficiently then follow the "without CLEARRAY®" water chemistry parameters as defined by the Association of Pool and Spa Professionals. CLEARRAY® requires an annual bulb replacement to properly sanitize your water.

 **TO DECREASE RISK OF INFECTION OR DISEASE!** Always maintain your spa filter as outlined below to ensure healthy spa water. Refer to pages 50-53 (Sec. 13.0) for additional information.

Required Filter Maintenance

Your new spa is equipped with an advanced water filtration system that provides unsurpassed water quality! To ensure maximum water quality at all times, you should clean the skimming filter cartridge every 3 months, or as necessary. See pages 50-53 (Sec. 13.0) for detailed filter cartridge cleaning instructions.

Required Water Replacement

 **TO DECREASE RISK OF INFECTION OR DISEASE!** You should replace the spa's water every 3 months. The frequency depends on a number of variables including frequency of use, number of users and attention paid to water quality maintenance. You will know it is time for a change when you cannot control sudsing and/or you can no longer get the normal feel or sparkle to the water, even though the key water balance measurements are all within the proper parameters. See pages 58-61 (Sec. 14.0) for additional information.

***** Spa operation subject to change without notice *****

Table of Contents

1.0	Important Spa Owner Information	1
2.0	FCC Notice	1
2.1	Industry Canada (IC) Information	1
3.0	Important Safety Instructions for all Spa Owners	2
3.1	Entrapment Risk	7
3.2	Hyperthermia	8
3.3	Important safety instructions	9
4.0	Choosing a Location	9
4.1	Outdoor Location	10
4.2	Indoor Location	11
5.0	General Electrical Safety Instructions	12
6.0	Electrical Installation Instructions (240V Service)	12
7.0	Power Requirements	16
8.0	Spa Fill Up Procedure	16
9.0	Spa Features	21
9.1	J-575™ Spa Features.....	21
9.2	J-575 Massage/Waterfall Selector Diagram	22
9.3	J-575 Air Controls Diagram.....	23
9.4	J-585™ Spa Features.....	24
9.5	J-585 Massage/Waterfall Selector Diagram	25
9.6	J-585 Air Controls Diagram.....	26
10.0	Registration and Start-up	27
10.1	Start-up Sequence	27
10.2	Register Your New Spa.....	27
10.3	ProTouch™ Glass Control Panel	28
11.0	Operating Instructions	30
11.1	ProTouch™ Glass Control Panel	30
11.2	Activating the Jets Pumps	30
11.3	Lights Menu	31
11.4	Interior Lights	31
11.5	Exterior Lights.....	32
11.6	Experience.....	33
11.7	Music Menu	33
11.8	Bluetooth® Pairing Instructions	34
11.9	Audio Settings Menu.....	35
11.10	CLEARRAY on Demand.....	36
11.11	Adjusting Jet Flow.....	36
11.12	Adjusting PowerPro™ MX2 Jets.....	36
11.13	Adjusting RX Jets	36
11.14	Waterfall Control	36

11.15	Air Controls	36
11.16	Selecting the Desired Massage Action	37
11.17	Optional BLUEWAVE® 2.0 Wireless Audio System	37
11.18	SmartTub™ System	37
12.0	Programming Instructions	39
12.1	Programming the Heating Mode	40
12.2	Programming the Primary Filter	40
12.3	Programming the Secondary Filter	42
12.4	Clean up Cycle	42
12.5	Blow-Out Cycle	42
12.6	Water Care Programming	43
12.7	Locking the Spa	45
12.8	Programming the Time and Date	47
12.9	Programming the Language	47
12.10	Wi-Fi Setup (not applicable if the SmartTub™ system is installed)	48
12.11	System Information	49
13.0	Spa Maintenance	50
13.1	Cleaning the Filter Cartridges	50
13.2	Draining and Refilling	54
13.3	Cleaning the Spa Interior	55
13.4	Pillow Care	56
13.5	Maintaining the Synthetic Cabinet	56
13.6	Cleaning the Control Panel	56
13.7	Cover Care and Maintenance	56
13.8	Winterizing	57
13.9	Restarting Your Spa in Cold Weather	58
14.0	Water Quality Maintenance	58
14.1	pH Control	59
14.2	Sanitizing	59
14.3	Other Additives	60
14.4	CLEARRAY® Water Purification System	60
14.5	CLEARRAY® Bulb Replacement and Quartz Tube Maintenance	61
15.0	Error/Display Messages	64
16.0	Troubleshooting Procedures	68
17.0	Typical Spa Wiring Diagrams	70
17.1	Wiring diagram for North American 60 Hz Models Only	70
18.0	Circuit Board Wiring Diagrams	71
18.1	Domestic 60Hz Wiring Diagram	71
18.2	Dip Switch Settings	72

1.0 Important Spa Owner Information

Your Jacuzzi® spa is constructed to the highest standards and is capable of providing many years of trouble-free use. However, because heat retentive materials are utilized to insulate the spa for efficient operation, an uncovered spa surface and wall fittings directly exposed to sunlight and high temperatures for an extended period are subject to permanent damage or discoloration. Damage caused by exposing the spa to this abuse is not covered under warranty. We recommend that you always keep the spa full of water when it is exposed to direct sunlight and that you keep the Jacuzzi insulating cover in place at all times when the spa is not in use. Read and carefully follow the requirements for your spa's support base found in the Section 4.0 titled, "Choosing a Location" (page 9).

Jacuzzi® spas constantly strives to offer the finest spas available, therefore, modifications and enhancements may be made which affect the specifications, illustrations and/or instructions contained herein.

2.0 FCC Notice

This device complies with part 15 of the FCC Rules. Operation is subject to the following two conditions: (1) This device may not cause harmful interference, and (2) this device must accept any interference received, including interference that may cause undesired operation.

This equipment has been tested and found to comply with the limits for a Class B Digital Device, pursuant to Part 15 of the FCC Rules. These limits are designed to provide reasonable protection against harmful interference in a residential installation. This equipment generates, uses and can radiate radio frequency energy and, if not installed and used in accordance with the instructions, may cause harmful interference to radio communications. However, there is no guarantee that interference will not occur in a particular installation. If this equipment does cause harmful interference to radio or television reception, which can be determined by turning the equipment off and on, the user is encouraged to try to correct the interference by one or more of the following measures:

1. Rearrange or relocate the receiving antenna;
2. Increase the separation between the equipment and receiver;
3. Connect the equipment into an outlet on a circuit different from the circuit connected;
4. Consult the dealer or an experienced radio/TV technician for help. (Changes or modifications not expressly approved by the party responsible for FCC compliance could void the user's authority to operate this equipment.)

2.1 Industry Canada (IC) Information

The installer of this radio equipment must ensure that the antenna is located or pointed such that it does not emit RF field in excess of Health Canada limits for the general population; consult Safety Code 6, obtainable from Health Canada's website: www.hc-sc.gc.ca.

3.0 Important Safety Instructions for all Spa Owners

READ AND FOLLOW ALL INSTRUCTIONS CAREFULLY!

This spa was manufactured to meet the standards and specifications outlined in the “Virginia Graeme Baker Pool and Spa Safety Act” (VGB Safety Act). When installing and using this spa, basic safety precautions should always be followed, including:

1.  **DANGER: RISK OF SEVERE INJURY OR DROWNING!**
 - Extreme caution must be exercised to prevent unauthorized access by children.
 - To avoid accidents, ensure that children do not use this spa unless supervised at all times. Adult supervision is a critical safety factor in preventing children from drowning.
 - Use the straps and clip tie downs to secure the spa cover when not in use. This will help discourage unsupervised children from entering the spa. Keep the spa cover secure in high-wind conditions.
 - There is no representation that the cover, clip tie-downs, or actual locks will prevent access to the spa.

2.  **DANGER: RISK OF SEVERE INJURY OR DROWNING!**
 - Keep hair, loose articles of clothing or hanging jewelry away from suction fittings, rotating jets or other moving components to avoid entrapment that could lead to drowning or severe injury.
 - Never use the spa unless all suction guards, filter, filter lid, or skimmer assembly are installed to prevent body and/or hair entrapment.
 - Never operate or use the spa if the filter, filter lid, or skimmer assembly are broken or any part of the skimmer assembly is missing. Please contact your dealer or nearest service center for service.
 - The suction fittings and suction covers in this spa are sized to match the specific water flow created by the pump(s). If it is necessary to replace the suction fittings, suction covers or pump(s), be sure that the flow rates are compatible and are in compliance with the VGB Safety Act.
 - Never replace a suction fitting or suction cover with one rated less than the flow rate marked on the original suction fitting. Using improper suction fittings or suction covers can create a body or hair suction entrapment hazard that may lead to drowning or severe injury.

3.  **DANGER: RISK OF SEVERE INJURY FROM ELECTRIC SHOCK OR DEATH FROM ELECTROCUTION!**
 - Install the spa at least 5 feet (1.5m), from all metal surfaces. As an alternative, a spa may be installed within 5 feet of metal surfaces if each metal surface is permanently connected (bonded) by a minimum No. 8 AWG (8.4 mm²) solid copper conductor attached to the wire connector on the grounding lug, inside the equipment compartment on the equipment box.



- A grounding wire connector is provided on this unit to connect a minimum No. 8 AWG (8.4 mm²) solid copper conductor between this unit and any metal equipment, metal enclosures of electrical equipment, metal water pipe, or conduit within 5 feet (1.5m) of the unit.
- Never permit any electrical appliance, such as a light, telephone, radio, television, etc. within 5 feet (1.5m) of a spa unless such appliances are built-in by the manufacturer.
- Never bring any electrical appliances into or near the spa.
- Never operate any electrical appliances from inside the spa or when you are wet.
- The electrical supply for this product must include a suitably rated switch or circuit breaker to open all ungrounded supply conductors to comply with Section 422-20 of the National Electrical Code/USA, ANSI/NFPA 70. The disconnecting means must be readily accessible and visible to the spa occupant but installed at least 5 feet (1.5m), from the spa.
- The electrical circuit supplied for the hot tub must include a suitable ground fault circuit interrupter (GFCI) as required by NEC Article 680-42.



4.  **WARNING: RISK OF SEVERE INJURY OR DEATH!**

- Extreme caution must be exercised to prevent diving or jumping into the spa or slipping and falling, which could result in unconsciousness, drowning, or serious injury. Remember that wet surfaces can be very slippery.
- Never stand, walk or sit on the top railing of the spa.

5.  **WARNING: RISK OF HYPERTHERMIA (OVER-HEATING) CAUSING SEVERE INJURY, BURNS, WELTS OR DEATH!**

- Water temperature in excess of 104°F (40°C) may be injurious to your health.
- Refer to Section 3.2 Hyperthermia for specific causes and symptoms of this condition.
- The water in the spa should never exceed 104°F (40°C). Water temperatures between 100°F (38°C) and 104°F (40°C) are considered safe for a healthy adult.
- Lower water temperatures are recommended for young children (children are especially sensitive to hot water) and when spa use may exceed 10 minutes.
- The Consumer Products Safety Commission/USA has stated that the water temperature in a spa should not exceed 104°F (40°C).
- Always test the spa water temperature before entering the spa. The user should measure the water temperature with an accurate thermometer since the tolerance of water temperature-regulating devices may vary as much as +/- 5°F (2°C).

6.  **WARNING: RISK OF SEVERE INJURY OR DEATH!**
- Since excessive water temperatures have a high potential for causing fetal damage during the early months of pregnancy, if pregnant or possibly pregnant, consult your physician before using a spa.
 - Pregnant or possibly pregnant women should limit spa water temperatures to 100°F (38°C).
 - Persons suffering from obesity or a medical history of heart disease, low or high blood pressure, circulatory system problems, diabetes, infectious diseases or immune deficiency syndromes should consult a physician before using a spa.
 - If you experience breathing difficulties in association with using or operating your spa, discontinue use and consult your physician.
 - Persons using medication should consult a physician before using a spa since some medication may induce drowsiness, while other medication may affect heart rate, blood pressure, and circulation.
 - Persons suffering from any condition requiring medical treatment, the elderly, or infants should consult with a physician before using a spa.
 - The use of alcohol, drugs, or medication before or during spa use may lead to unconsciousness with the possibility of drowning.
7.  **WARNING: RISK OF SEVERE INJURY OR DEATH!**
- Prolonged immersion in a spa may be injurious to your health.
 - Observe a reasonable time limit when using the spa. Exposures at higher temperatures can cause high body temperature (over-heating). Symptoms may include dizziness, nausea, fainting, drowsiness, and reduced awareness. These effects could possibly result in drowning or serious injury.
 - Never use a spa immediately following strenuous exercise. Enter and exit the spa slowly. Wet surfaces can be slippery.
8.  **WARNING: TO DECREASE RISK OF INFECTION OR DISEASE!**
- To reduce the risk of contracting a waterborne illness (e.g. an infection, bacteria or virus) and/or respiratory ailments, maintain water chemistry within the parameters listed on the inside cover of this manual and consult with a licensed engineer regarding proper ventilation if installed indoors or in an enclosed area.
 - People with infectious diseases should not use a spa to avoid water contamination, which could result in spreading infections to others.
 - Always shower before and after using your spa. Maintain water chemistry in accordance with manufacturer's instructions. Failure to do so may result in contracting a waterborne illness (e.g. an infection, bacteria or virus).

9.  **WARNING:** In addition to maintenance of filters and water chemistry, proper ventilation is recommended to reduce the risk of contracting a waterborne illness (e.g. an infection, bacteria or virus) and/or respiratory ailments that could be present in the air or water. Consult a licensed architect or building contractor to determine your specific needs if installing your hot tub indoors.
10. **CAUTION: TO DECREASE RISK OF PRODUCT DAMAGE.**
- Maintain water chemistry in accordance with manufacturer's instructions.
 - Proper chemical maintenance of spa water is necessary to maintain safe water and prevent possible damage to spa components.
11.  **WARNING: RISK OF SEVERE INJURY OR DEATH!** The appliance is not intended for use by persons (including children) with reduced physical, sensory or mental capabilities, or lack of experience or knowledge, unless they have been given supervision or instruction concerning use of the appliance by a person responsible for their safety.
12. **NOTE:** This spa is not intended nor designed to be used in a commercial or public application. The spa buyer shall determine whether there are any code restrictions on the use or installation of this spa since local code requirements vary from one locality to another.

Hot Tub Safety Literature

To ensure you have a safe and enjoyable hot tub experience, learn all you can about hot tub safety and emergency procedures. Especially useful are the brochures listed below:

- [Children Aren't Waterproof](#)
- [Pool and Spa Emergency Procedures For Infants and Children](#)
- [Layers of Protection](#)
- [The Sensible Way to Enjoy Your Spa or Hot Tub](#)

The Association of Pool and Spa Professionals publishes these brochures. To acquire a brochure:

- Ask your hot tub dealer (they may have copies)
- Go to <http://apsp.org>
- Conduct your own search on the internet
- Write to the following address:

The Association of Pool and Spa Professionals
 2111 Eisenhower Avenue
 Alexandria VA 22314
 703.838.0083

FOR CALIFORNIA RESIDENTS ONLY
 NUR FÜR EINWOHNER KALIFORNIENS
 POUR LES RÉSIDENTS DE LA CALIFORNIE SEULEMENT
 PARA RESIDENTES DE CALIFORNIA ÚNICAMENTE



WARNING: Drilling, sawing, sanding or machining wood products can expose you to wood dust, a substance known to the State of California to cause cancer. Avoid inhaling wood dust or use a dust mask or other safeguards for personal protection. For more information go to www.p65Warnings.ca.gov/wood



ACHTUNG: Das Bohren, Sägen, Schleifen oder Zerspanen von Holzprodukten kann Stäube freisetzen. Diese Substanz gilt im US-Bundesstaat Kalifornien als krebserregend. Möglichst keinen Holzstaub einatmen bzw. eine Staubmaske oder anderweitige persönliche Schutzmaßnahmen einsetzen. Weitere Informationen finden Sie auf www.P65Warnings.ca.gov/wood



AVERTISSEMENT: Le forage, le sciage, le ponçage ou l'usinage des produits du bois peuvent vous exposer à la poussière de bois, une substance connue dans l'État de Californie pour causer le cancer. Éviter d'inhaler la poussière de bois ou utiliser un masque antipoussières ou d'autres mesures de protection personnelle. Pour de plus amples renseignements, consulter le site www.P65Warnings.ca.gov/wood



ADVERTENCIA: Perforar, cortar, lijarse o usar máquinas con productos de madera le puede exponer a polvo de madera, una sustancia reconocida por el Estado de California como causante de cáncer. Evite inhalar polvo de madera o utilice una máscara antipolvo u otros resguardos para protección personal. Para más información, visite www.P65Warnings.ca.gov/wood

6530-460 Rev A (12/18)

FOR CALIFORNIA RESIDENTS ONLY
 NUR FÜR EINWOHNER KALIFORNIENS
 POUR LES RÉSIDENTS DE LA CALIFORNIE SEULEMENT
 PARA RESIDENTES DE CALIFORNIA ÚNICAMENTE



WARNING: Cancer and Reproductive Harm
www.p65Warnings.ca.gov



ACHTUNG: Krebserregend und mit fortpflanzungsschädigender Wirkung-www.p65Warnings.ca.gov



AVERTISSEMENT: Cancer et danger pour la reproduction
www.p65Warnings.ca.gov



ADVERTENCIA: Cáncer y daño reproductivo
www.p65Warnings.ca.gov

6530-464 Rev A (12/18)

3.1 Entrapment Risk

The Consumer Products Safety Commission/USA has reported that users of pools and spas have become entrapped (stuck) to drain and/or suction fittings causing death, drowning, or serious injury (see diagram below). This spa was manufactured to meet the standards and specifications outlined in the “Virginia Graeme Baker Pool and Spa Safety Act” (VGB Safety Act). Entrapment risk can be minimized if proper precautions are taken.



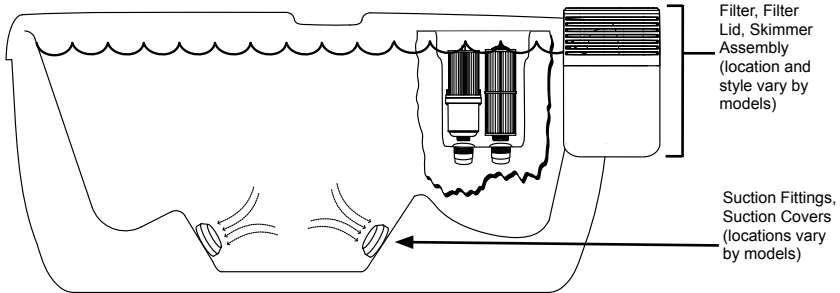

DANGER: RISK OF PERSONAL INJURY OR DEATH!

Never operate the spa if a suction fitting, suction cover, filter, filter lid or skimmer assembly are broken, damaged or missing.





Note: Suction covers must be replaced every 7 years.

1.  **DANGER: RISK OF SEVERE INJURY OR DROWNING!**
Hair entrapment: May occur if hair is entangled, knotted or snagged in a drain suction or skimmer assembly. This has been reported in persons who when submerge themselves underwater, allowing hair to come close and/or within the reach of the suction fittings, suction covers or skimmer assembly.
 - Keep hair away from suction fittings, suction covers, filter, filter lid or skimmer assembly.
 - Children are at risk for hair entrapment if swimming under water.
 - Never allow children to play or get near the suction fittings, suction covers, filter, filter lid or skimmer assembly.

2.  **DANGER: RISK OF SEVERE INJURY OR DROWNING!**
Limb entrapment: May occur when a limb becomes entrapped, inserted or sucked into a suction or outlet opening.
 - Always keep suction fittings, suction covers, filter, filter lid or skimmer assembly in place when operating to avoid limb entrapment.
 - Never allow children to play or get near the suction fittings, suction covers, filter, filter lid or skimmer assembly.

3.  **DANGER: RISK OF SEVERE INJURY OR DROWNING!**
Body entrapment: May occur when part of the torso becomes entrapped, inserted or sucked into a suction or outlet opening.
 - Never allow children to play or get near the suction fittings, suction covers, filter, filter lid or skimmer assembly.

4.  **DANGER: RISK OF SEVERE INJURY OR DROWNING!**
Evisceration (disembowelment) entrapment: May occur when the buttocks becomes entrapped, inserted or sucked into a suction or outlet opening.
 - Never sit on suction fittings, suction covers, filter, filter lid or skimmer assembly.
 - Never allow children to play or get near the suction fittings, suction covers, filter, filter lid or skimmer assembly.

5.  **DANGER: RISK OF SEVERE INJURY OR DROWNING!**
Mechanical entrapment: May occur when jewelry, swimsuit, or hair accessories become entangled, knotted or snagged in a drain suction or skimmer assembly.
 - Never allow your jewelry, swimsuit, or hair accessories to come close to the suction fittings, suction covers or skimmer assembly.
 - Never allow children to play or get near the suction fittings, suction covers, filter, filter lid or skimmer assembly.

3.2 Hyperthermia

Prolonged immersion in hot water may induce hyperthermia (overheating). The use of alcohol or drugs can greatly increase the risk of fatal hyperthermia in spas. A description of the causes, symptoms, and effects of hyperthermia are as follows:

Hyperthermia occurs when the internal temperature of the body reaches a level several degrees above the normal body temperature of 98.6°F (37°C). The symptoms of hyperthermia include drowsiness, lethargy (fatigue), and an increase in the internal temperature of the body (feeling of being too hot). The effects of hyperthermia include:

- Unawareness of impending hazard;
- Failure to perceive heat;
- Failure to recognize the need to exit spa;
- Physical inability to exit spa;
- Fetal damage in pregnant women; and
- Unconsciousness and danger of drowning.

A Warning Sign is provided in your warranty packet. Please install at a location near your spa, where it is visible to users of the spa. For additional or replacement Warning Signs please contact your local Jacuzzi dealer and reference item number #6530-082.

3.3 Important safety instructions

When using this electrical equipment, basic safety precautions should always be followed, including the following:

1. **READ AND FOLLOW ALL INSTRUCTIONS.**
2. A green colored terminal or a terminal marked G, Gr, Ground, Grounding or the  symbol* is located inside the supply terminal box or compartment. To reduce the risk of electric shock, this terminal must be connected to the grounding means provided in the electric supply service panel with a continuous copper wire equivalent in size to the circuit conductors that supply this equipment. *IEC Publication 417, Symbol 5019.
3. At least two lugs marked “Bonding Lugs” are provided on the external surface or on the inside of the supply terminal box/ compartment. To reduce the risk of electric shock, connect the local common bonding grid in the area of the spa to these terminals with an insulated or bare copper conductor not smaller than No. 6 AWG (10 mm²).
4. All field-installed metal components such as rails, ladders, drains or other similar hardware within 10 feet (3m) of the spa shall be bonded to the equipment grounding buss with copper conductors not smaller than No. 6 AWG (10 mm²).
5. **SAVE THESE INSTRUCTIONS.**

4.0 Choosing a Location

IMPORTANT: Because of the combined weight of the spa, water and users, it is extremely important that the base upon which the spa rests be smooth, flat, level and capable of uniformly supporting this weight, without shifting or settling, for the entire time the spa is in place. Visit www.Jacuzzi.com for weight information. If the spa is placed on a surface, which does not meet these requirements, damage to the skirt and/or the spa shell may result. Damage caused by improper support is not covered under warranty. It is the responsibility of the spa owner to assure the integrity of the support at all times. We recommend a poured, reinforced concrete slab with a minimum thickness of 4 inches (10 cm). Wood decking is also acceptable provided it is constructed so that it meets the requirements outlined above.



WARNING: For spas that are to rest on balconies, roofs or other platforms not specifically tied into main structural support, consult a professional Structural Engineer with experience in this type of application.



WARNING: Proper drainage is required. The installation must not allow the spa equipment bay to become flooded or wetted (by external water). It is your responsibility, and the responsibility of any installation contractor you hire, to make sure that all applicable codes and/or local construction requirements are met. If in doubt, refer to the building authority responsible for approving the proposed installation site.

The spa must be installed in such a manner as to provide drainage away from it. Placing the spa in a depression without provisions for proper drainage could allow rain, overflow, leaks from spa plumbing, and other casual water to flood the equipment and create a wet condition in which it would sit in. For spas which will be installed below grade or recessed into a floor or deck, install so as to permit access to the equipment, either from above or below, for servicing. Make certain that there are no obstructions, which would prevent removal of all side cabinet side panels and access to the jet components, especially on the side with the equipment bay.



CAUTION: If the spa is indoors or located in an enclosed area, proper ventilation should be discussed with an Engineer or authority competent enough to understand the necessary provisions needed to vent moist or heated air and air associated with chemical odors outdoors. **When the spa is in use considerable amounts of moisture will escape potentially causing mold and mildew. This can cause health risk.** Over time, this can damage certain surfaces, surroundings, and equipment.

4.1 Outdoor Location

In selecting the ideal outdoor location for your spa, we suggest that you take into consideration:

- The proximity to changing area and shelter (especially in colder weather).
- The pathway to and from your spa (this should be free of debris so that dirt and leaves are not easily tracked into the spa).
- The closeness to trees and shrubbery (remember that leaves and birds could create extra work in keeping the spa clean).
- A sheltered environment (less wind and weather exposure can result in lowered operation and maintenance costs).
- The overall enhancement of your environment. It is preferable not to place the spa under an unguttered roof overhang since run-off water will shorten the life expectancy of the spa cover.
- For spas that are to rest on balconies, roofs or other platforms not specifically tied into main structural support, consult a professional Structural Engineer with experience in this type of application.
- In the unlikely event that you should ever need to access or gain entry to any portion of the spa for servicing, it is highly recommended that you plan your outdoor installation to provide full access to the

entire spa. Please take this into consideration when placing the spa in a deck or enclosed by a surrounding.

- Consider locating your spa away from any reflective surface or glass to prevent any damage to the synthetic skirt.
- Do not shim the spa. To ensure proper support the spa must sit flat on the intended foundation.

4.2 Indoor Location

For indoor installations many factors need to be considered before installing a spa indoors.



WARNING: In addition to maintenance of filters and water chemistry, proper ventilation is recommended to reduce the risk of contracting a waterborne illness (e.g. an infection, bacteria or virus) and/or respiratory ailments that could be present in the air or water. Consult a licensed architect or building contractor to determine your specific needs if installing your hot tub indoors.

- **Proper Foundation: Consult a Structural Engineer when considering a foundation that will adequately support the spa the entire time it is in place.** Proper support is critical especially if the spa is to rest on a second story or higher. For spas that are to rest on balconies, roofs or other platforms not specifically tied into the main structural support, you should consult a professional Structural Engineer with experience in this type of application.
- **Proper Drainage: It is extremely important to have in place measures to sufficiently handle excessive water spillage.** Be sure the flooring in which the spa rests on has adequate drainage and can handle the entire contents of the spa. Be sure to make provisions for ceilings and other structures that may be below the spas installation. Areas around your spa can become wet or moist so all flooring and subsequent furniture, walls and adjacent structures should be able to withstand or resist water and moisture.
- **Proper Ventilation: Proper ventilation should be discussed with an Engineer or authority competent enough to understand the necessary provisions needed to vent moist or heated air and air associated with chemical odors outdoors.** When the spa is in use considerable amounts of moisture will escape, potentially causing mold and mildew over time, which can damage certain surfaces and/or surroundings.
- **Sufficient Access:** In the unlikely event that you should ever need to access or gain entry to any portion of the spa for servicing, it is highly recommended that you plan your indoor installation to provide full access to the entire spa.
- **Warranty:** Damage caused by not following these guidelines or any improper installation not in accordance to local codes or authorities is not covered under the spas warranty. Please consult your local state or city building ordinances.
- **Do not shim the spa.** To ensure proper support the spa must sit flat on the intended foundation.

5.0 General Electrical Safety Instructions

Your new Jacuzzi® spa is equipped with the ProTouch™ system. It contains the most advanced safety and self-protective equipment in the industry. Nonetheless, this spa must be installed properly to ensure dependable usage.

Please contact your local Jacuzzi dealer or local building department should you have any questions regarding your installation.

Proper grounding is extremely important. Jacuzzi spas are equipped with a current collector system. A pressure wire connector is provided on the surface of the control box, located inside the equipment door (page 15) to permit connection of a bonding wire between this point and any ground metal equipment, metal water pipe or conduit within 5 feet (1.5m) of the spa, or copper clad grounding rod buried within 5 feet (1.5m) of the spa. Bonding wire must be at least No. 8 AWG (8.4 mm²) solid copper wire. This is a most important safety assurance feature. Before installing your spa, check with your local building department to ensure installation conforms to local building codes.



6.0 Electrical Installation Instructions (240V Service)

IMPORTANT NOTICE: The electrical wiring of this spa must meet the requirements of the National Electrical Code/USA (NEC) and/or any applicable state or local codes. The electrical circuit must be installed by a qualified electrician and approved by a local building/electrical inspection authority.



1. **DANGER: TO DECREASE THE RISK OF SHOCK, PRODUCT DAMAGE OR ELECTRICAL FIRE.**

This spa must be permanently connected (hard-wired) to the power supply. **No plug-in connections or extension cords are to be used in conjunction with the operation of this spa.** Supplying power to the spa, which is not in accordance with these instructions, will void both the independent testing agency listing and the manufacturer's warranty.

2. The power supplied to this spa must be a dedicated circuit with no other appliances or lights sharing the power provided by the circuit.
3. To determine the current, voltage and wire size required, refer to Section 7.0 "Power Requirements" (page 16) for your specific spa model.
 - Wire size must be appropriate per NEC and/or local codes.
 - The spa controller's terminal block will accept a maximum wire size of 6 AWG.
4. The electrical supply for this product must include a suitably rated switch or circuit breaker to open all ungrounded supply conductors to comply with Section 422-20 of the National Electrical Code/USA, ANSI/NFPA

70. The disconnecting means must be readily accessible to the spa's occupant but installed at least 5 feet (1.5m) from spa water.
5. The electrical supply for this product must include a suitably rated isolating switch and circuit breaker to comply with local electrical regulations. This RCD/GFCI circuit breaker must be installed at the power supply in the house electrical box.
6. The electrical circuit supplied for the spa must include a suitable ground fault circuit interrupter (GFCI) as required by NEC Article 680-42/USA.
8. To gain access to the spa's power terminal block, you will need to remove the corner and center cabinet panels.
9. Grab one of the corner panels, from the bottom, where it touches the bottom pan. Then gently pull the panel forward to unsnap it from the holding clip, Figure A. Place the corner panel in a safe location to prevent from damaging it. Repeat the steps to remove the other corner panel.
10. Now you need to remove the center panel. Grab the sides of the panel and gently pull the cabinet forward until all the clips have been release then pull up to remove, Figure B. Place the panel in a safe location to prevent from damaging it.
11. Select the power supply entrance you want to use, Figure C. Make sure to install a 3/4" electrical fitting and conduit through the large opening provided in the bottom of the control box so you can feed the cable through to the terminal block.
12. Then remove the door screws for the access door on the control box (Figure D).
13. Connect wires to the terminal block (Figures D et E). **ALL WIRES MUST BE SECURELY CONNECTED** or equipment damage could result!
14. Install the control access box door and reinstall the cabinet panels.

Figure A
Equipment Area

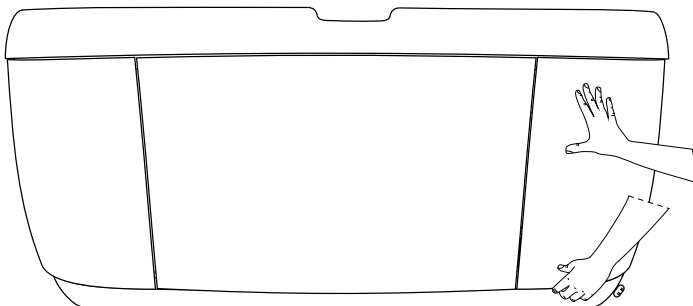

**Figure B
Equipment Area**

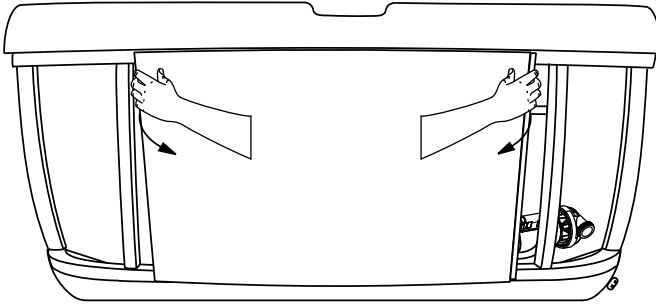

**Figure C
Equipment Area**

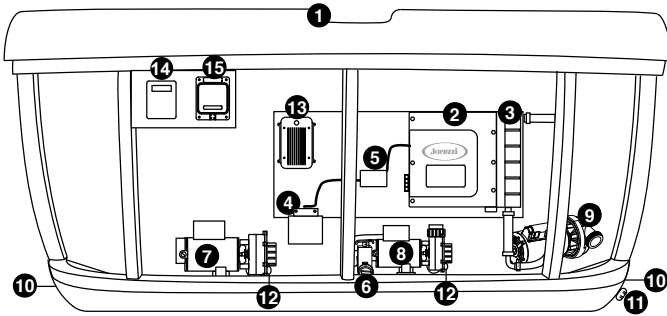

Note: Equipment location (such as pumps, CLEARRAY system, stereo, drain, heater etc.) varies by model.

- | | |
|---|----------------------------------|
| 1. ProTouch™ Glass Control Panel | 7. Jets Pump |
| 2. ProTouch™ Control Box | 8. Filter/Circulation Pump |
| 3. Heater | 9. Jets Pump |
| 4. CLEARRAY Water Purification System | 10. Power Supply Entrance(s) |
| 5. CLEARRAY Water Purification System Ballast | 11. Spa Drain Valve |
| 6. QuickDrain™ | 12. Pump Drain Plugs(s) |
| | 13. BLUEWAVE 2.0 Wireless Stereo |
| | 14. SmartTub™ System |
| | 15. Bridge (for SmartTub System) |

Figure D
Terminal Block Connection

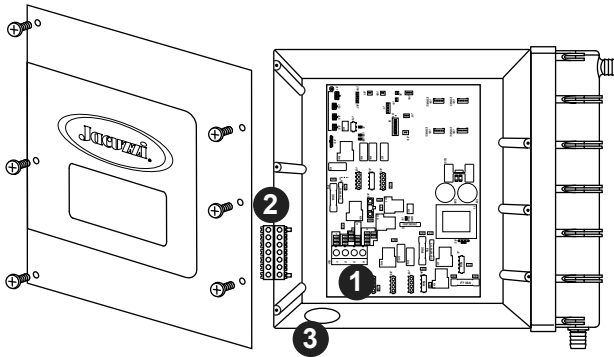

1. Main Terminal Block
2. Bonding Lug/Grounding Terminal
3. Power wires Entrance (Electrical fitting and conduit must be installed)

Figure E
Terminal Connections
(North American 60Hz 240 VAC)

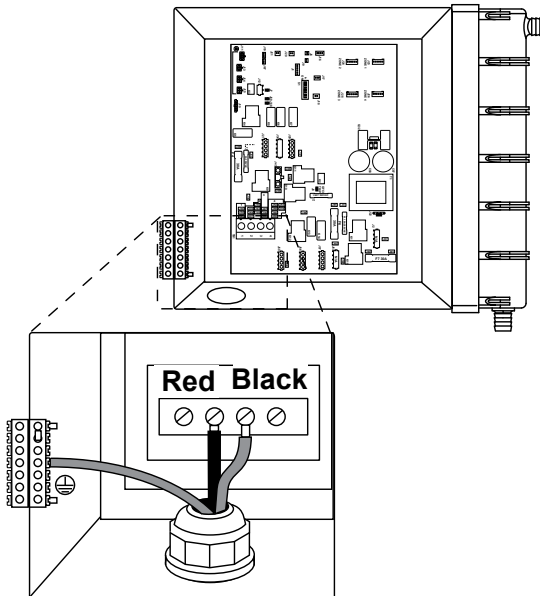

7.0 Power Requirements

Jacuzzi® spas are designed to provide optimum performance and flexibility of use when connected to their maximum electrical service. They are configured at the factory. The most common electrical connections are listed below. Reference page 72 for dip switch settings.

- These models come set for 50A logic. If you prefer, your qualified technician can perform a logic modification that allows the spas to operate on a different electrical service.

North American Models (60 Hz)			
Voltage:	240 VAC	240 VAC	240 VAC
Max. Current Draw:	32A	40A	48A
Frequency:	60 Hz	60 Hz	60 Hz
Number of Wires:	3	3	3
Circuit Breaker (2-Pole):	40A*	50A**	60A***
* In 40A configuration, the heater <u>will not operate</u> while either jets pump is running.			
** In 50A configuration, the heater <u>will operate</u> when one jets pump is running, but <u>will not operate</u> while both jets pumps are running. <i>This is the factory setting.</i>			
*** In 60A configuration the heater <u>will operate</u> while both jets pumps are running.			

8.0 Spa Fill Up Procedure

For best results, read each step in its entirety before proceeding with this procedure. Make sure all drains are closed before you begin, page 14.

1. Prepare The Spa For Filling

- Clear all debris from the spa. (Although the spa shell has been polished at the factory, you may want to treat it with a specially formulated spa cleaner.) Consult your authorized Jacuzzi dealer for additional information prior to filling spa.
- If using the primary filter fitting to fill, remove filter cover, then remove filter cartridge as outlined in Section 13.1 (page 50).

IMPORTANT: In most cases, filling the spa by placing the hose in the footwell will not create an airlock, page 68. If you experience an airlock we recommend filling by placing the end of your garden hose into the primary filter fitting inlet. This wall fitting is the one with the grid, page 50.

2. Fill Spa

- Place the end of your garden hose into the empty primary filter fitting or into the footwell.

-  **WARNING: TO DECREASE RISK OF INFECTION OR DISEASE.**

Fill hot tub with clean tap water from garden hose, to reduce risk of contracting a waterborne illness (e.g. an infection, bacteria or virus) and/or respiratory ailments. Fill until water covers all jets but does not touch the bottom of the lowest headrest (DO NOT OVERFILL!).

CAUTION: TO DECREASE BUILD UP ON COMPONENTS AND MINIMIZE ACRYLIC DAMAGE.

Never fill with water from a water softener. If your water is extremely “hard,” it is preferable to fill half-way with hard water and the rest of the way with softened water. Water that is too soft can be corrosive to metal components.

3. Turn On Power

Turn on power to spa at the home’s circuit breaker. The heater and filter/circulation pump will automatically activate. If the screen displays either a “Cool Warning” or “Freeze Protection” error, this is normal. Normally, at the initial fill, the water tends to be cold. Refer to page 65 for additional information.

4. Activate Jets Pumps

Turn on jet pumps when adding chemicals in step 5 (see Section 11.2, page 30 to activate jets).

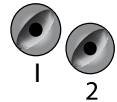

5. Add Start-Up Chemicals

Add the spa water chemicals as recommended by your authorized Jacuzzi spa dealer. See Section titled “Water Quality Maintenance” (page 58) for general guidance.



WARNING: RISK OF POISONING OR DEATH.

Never leave chemicals opened and accessible to anyone. Use chemicals according to the vendor’s instructions. Always store chemicals in a safe and/or locked location. Keep away from and out of reach of children.



6. Establish A Stable Sanitizer Reading

Establish a stable sanitizer reading of no less than 1.0 ppm free chlorine or 2.0 ppm bromine. To ensure healthy water conditions, always maintain a constant sanitizer reading within the levels recommended on the inside cover of this manual.

7. Set Spa To Heat

To warm spa water to a comfortable temperature, follow these steps:



- The display on the control panel displays the actual temperature of the spa water. Tap  or  to increase or decrease the water temperature in 1°F (0.5°C) increments.
- The heater will turn off 1°F (0.5°C) above set temperature and turn on 2°F (1°C) below set temperature.

Note: The temperature range for the spa is 65 to 104°F (18.33 to 40°C). To activate the **Extended Temperature feature** that allows the spa to reach 106°F (41°C), see page 67.

Important Heater Details:

- The maximum temperature for which the spa can be set is 104°F (40°C) and the minimum is 65°F (18.33°C).
- For North American spas: With a 50 amp service, turn off one of the jet pumps to operate heater. With a 40 amp service, turn off both jet pumps to operate heater. With a 60 amp service, the heater will operate with both jet pumps on.
- Setting the thermostat at maximum will not accelerate the heating process. This will only result in a higher ultimate temperature.
- The heater operates until the water reaches 1°F (0.5°C) above the programmed “set temperature,” then turns off. The heater will reactivate after the water cools to approximately 2°F (1°C) below the “set temperature.”

8. Place Cover On Spa

- Keeping the insulating cover in place anytime the spa is not in use will reduce the time required for heating, thereby minimizing operating costs.
- The time required for initial heat-up will vary depending on the starting water temperature.



DANGER: RISK OF PERSONAL INJURY.

Check water temperature carefully before entering hot tub! Excessive water temperature can cause burns, welts and body temperature to rise, hyperthermia (over-heating).

Decontamination Procedure

Steps 9-15 below are only required when sanitizer levels are unstable after performing Spa Fill Up Procedures steps 1-6. Disregard steps 9-15 below if sanitizer levels remain stable after performing steps 1-6 above (refer to the inside cover of the manual).

Note: The “Decontamination Procedure” should also be used after the spa has been “Winterized” (Sec. 13.8, page 57) or has been sitting without power for an extended period.

9. Add 2.5 ounces of sodium dichlor for every 100 gallons of water. Refer to the table below for approximate water fill volume by model.



CAUTION: RISK OF PERSONAL INJURY OR SPA DAMAGE!

Never add chlorine tablets (trichlor) or acid to your hot tub for any reason! These chemicals may damage components within your hot tub, burn or irritate your skin, create a rash, and void the manufacturer warranty for your spa.

Water Fill Volume by Model

Model	Average Fill Volume*	Sodium Dichlor
J-575.....	445 Gal (1,685 L)	11.0 oz
J-585.....	440 Gal (1,666 L)	11.0 oz

*Use average fill volume for chemical maintenance

10. Leave spa cover open during this step to allow excessive chemical vapors to exit spa, protecting pillows and plastic knobs from chemical attack. If spa is indoors, open doors and windows for proper ventilation. Turn on all spa jet pumps for 1 hour, open all air controls, and place all massage selector knob(s) in their center “combo” position.



Note: You will need to activate the jet pumps every 20 minutes since these functions have an automatic 20-minute time-out that turns them off.



WARNING: RISK OF PERSONAL INJURY!

- To decrease the risk of injury, drowning or entrapment, never leave your hot tub unattended for any reason while the cover is open and accessible, especially to small children and animals!
- Precautions should be taken to minimize your exposure to chemical vapors (that could cause lung, brain, or skin damage).

11. Turn off power to the spa at the circuit breaker, then drain tub as outlined in Section 13.2 (page 54).
12. Refill spa with clean tap water from garden hose until water covers all jets but does not touch the bottom of the lowest headrest with all headrests in their lowest position (DO NOT OVERFILL!)

CAUTION: TO DECREASE BUILD UP ON COMPONENTS AND MINIMIZE ACRYLIC DAMAGE.

Never fill with water from a water softener. If your water is extremely “hard,” it is preferable to fill halfway with hard water and the rest of the way with softened water. Water that is too soft can be corrosive to metal components.

13. Consult your authorized Jacuzzi dealer for chemical recommendations, then add chemicals to hot tub water to achieve a constant sanitizer reading within the levels recommended on the inside cover of this manual.
14. Turn on jet pumps when adding chemicals to ensure proper mixing and leave your hot tub cover open until the sanitizer level becomes stable to protect pillows and plastic knobs from chemical attack. Refer to the inside cover of the manual.



WARNING: RISK OF PERSONAL INJURY.

- To decrease the risk of injury, entrapment or drowning, never leave your hot tub unattended for any reason while the cover is open and accessible to small children and animals!
- To decrease the possibility of contracting a waterborne illness (e.g. an infection, bacteria or virus) and/or respiratory ailments, maintain water chemistry within step 6 parameters. If you or other bathers experience such a condition, discontinue use and seek medical attention.

15. Establish a sanitizer reading no less than 1.0 ppm free chlorine or 2.0 ppm bromine, then allow the hot tub to set undisturbed for 8 hours. Retest water after 8 hours to determine if sanitizer levels are stable. If sanitizer levels are stable, your spa is ready for use. To ensure healthy water conditions, always maintain a constant sanitizer reading within the levels recommended on the inside cover of this manual. If sanitizer levels are not stable at this time, it will be necessary to repeat this procedure in its entirety until stable sanitizer readings are achieved.

IMPORTANT: If the CLEARRAY® water purification system is removed from the hot tub or is not operating effectively follow the “without CLEARRAY®” water chemistry parameters as defined by the Association of Pool and Spa Professionals.

16. After adequate sanitizer levels are achieved, close all spa air controls to maximize heat retention when spa is not in use.

9.0 Spa Features
9.1 J-575™ Spa Features

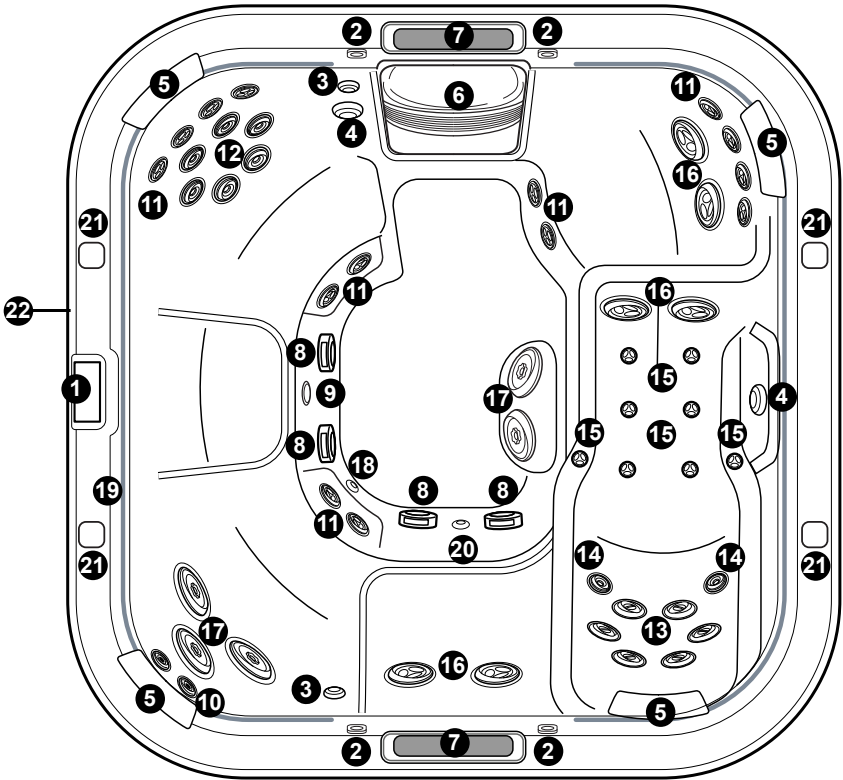

- | | |
|--|---|
| 1. Control Panel | 13. RX Jets (6 ea.) |
| 2. Air Control Valves (4 ea.)
Introduce Air to Specified Jet Groups | 14. FX Directional Jets (2 ea.) |
| 3. Waterfall Control Valve (2 ea.) | 15. PX Jets (8 ea.) |
| 4. Massage Selectors (2 ea.)
Controls Specified Jet Groups) | 16. FX2-S Jets (6 ea.) |
| 5. Pillows | 17. MX2 Jets (5 ea.) |
| 6. Filter/Skimmer Grill | 18. Gravity Drain/Heater Input/
CLEARRAY Return Fitting |
| 7. Waterfalls (2 ea.) | 19. Interior Perimeter Lighting |
| 8. Suction Covers (4 ea.) | 20. Waterfall Filtration Return |
| 9. Underwater Light | 21. Optional Audio System
Speakers (4 ea.) |
| 10. NX Jets (2 ea.) | 22. Optional BLUEWAVE 2.0
Wireless Stereo Audio System
(located behind cabinet panel) |
| 11. FX Spinner Jets (14 ea.) | |
| 12. FX Jets (6 ea.) | |

Spa features subject to change without notice

9.2 J-575 Massage/Waterfall Selector Diagram

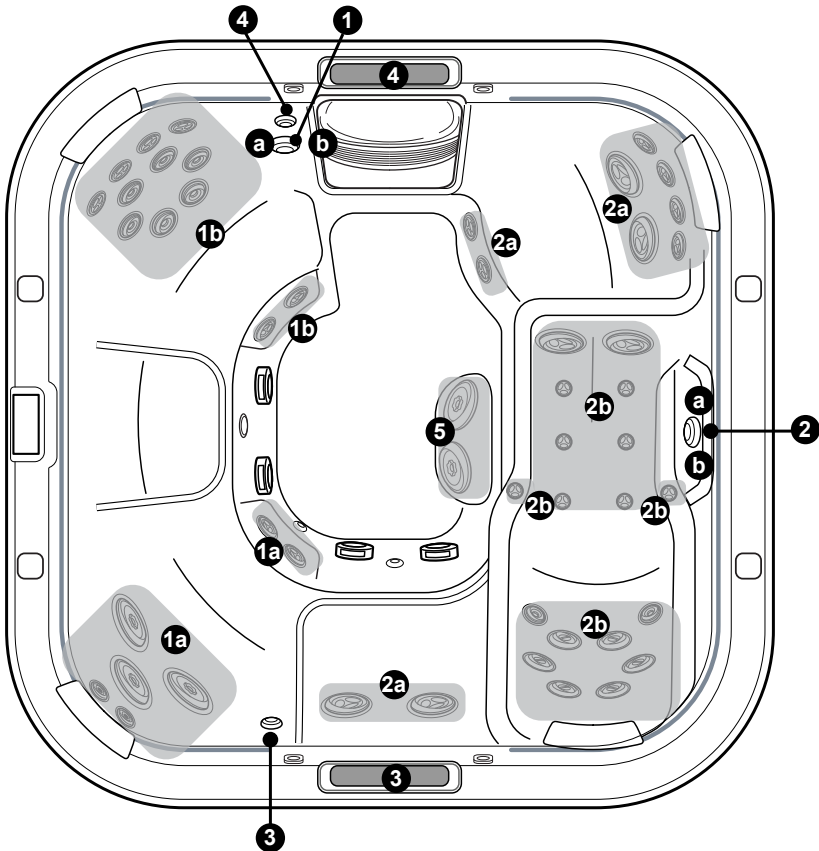

Massage Selectors (1-2)

- Massage selector 1 diverts jets pump 1 output between jets groups 1a-1b.
- Massage selector 2 diverts jets pump 2 output between jets groups 2a-2b.

Waterfall Selectors (3-4)

- Waterfall selector (3) controls circulation pump output to waterfall (3).
- Waterfall selector (4) controls circulation pump output to waterfall (4).

Jets Without Massage Selector Controls (5)

Jets (5) are always on when jets pump 1 is running.

9.3 J-575 Air Controls Diagram

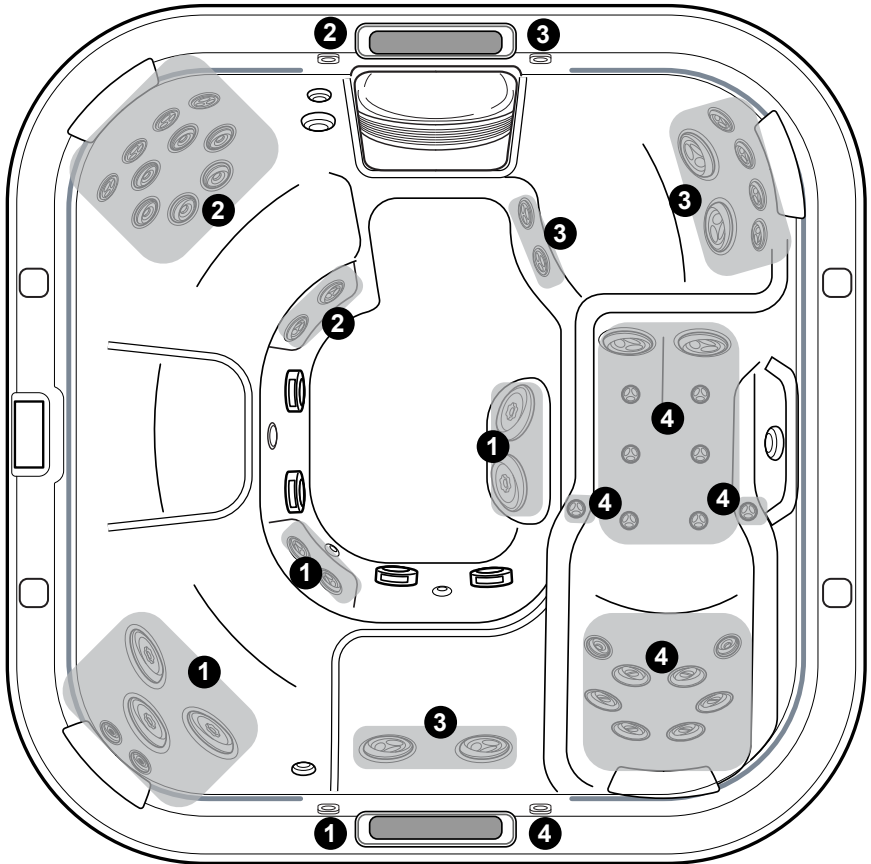

Air Controls Operation

- Toggle air controls 1-4 to add air to designated jet groups.

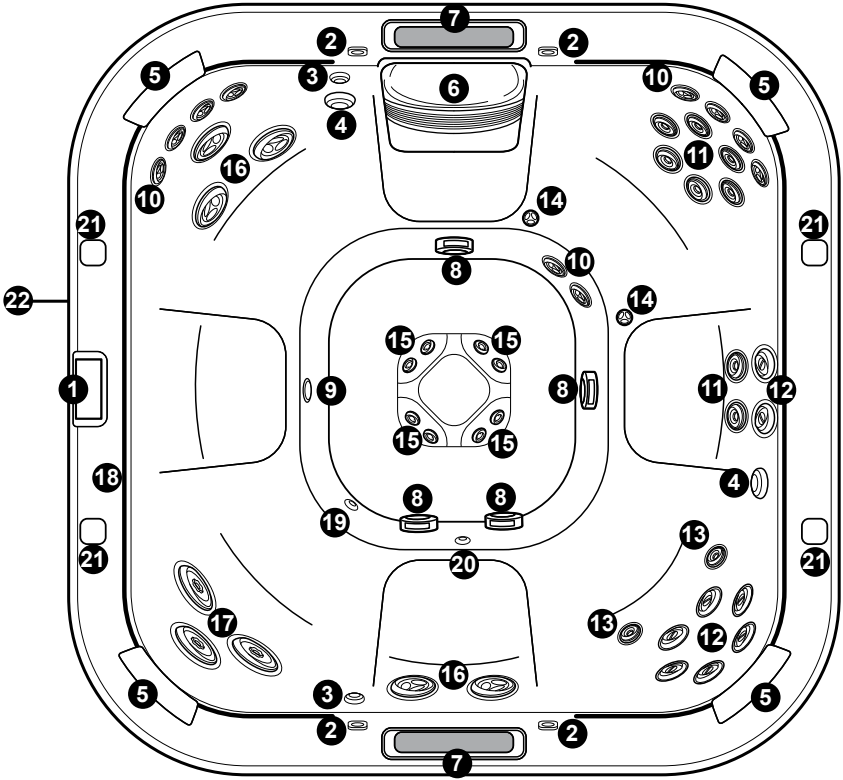

- | | |
|--|---|
| 1. Control Panel | 13. FX Directional Jets (2 ea.) |
| 2. Air Control Valves (4 ea)
Introduce Air to Specified Jet
Groups | 14. PX Jets (2 ea.) |
| 3. Waterfall Control Valve | 15. FX Small Jets (8 ea.) |
| 4. Massage Selectors (2 ea.)
Controls Specified Jet Groups) | 16. FX2S Jets (5 ea.) |
| 5. Pillows | 17. MX2 Jets (3 ea.) |
| 6. Filter/Skimmer Grill | 18. Interior Perimeter Lighting |
| 7. Waterfalls (2 ea.) | 19. Gravity Drain/Heater Input/
CLEARRAY Return Fitting |
| 8. Suction Covers (4 ea.) | 20. Waterfall Filtration Return |
| 9. Underwater Light | 21. Optional Audio System
Speakers (4 ea.) |
| 10. FX Spinner Jets (10 ea.) | 22. Optional BLUEWAVE 2.0
Wireless Stereo Audio System
(located behind cabinet panel) |
| 11. FX Jets (8 ea.) | |
| 12. RX Jets (8 ea.) | |

Spa features subject to change without notice

9.5 J-585 Massage/Waterfall Selector Diagram

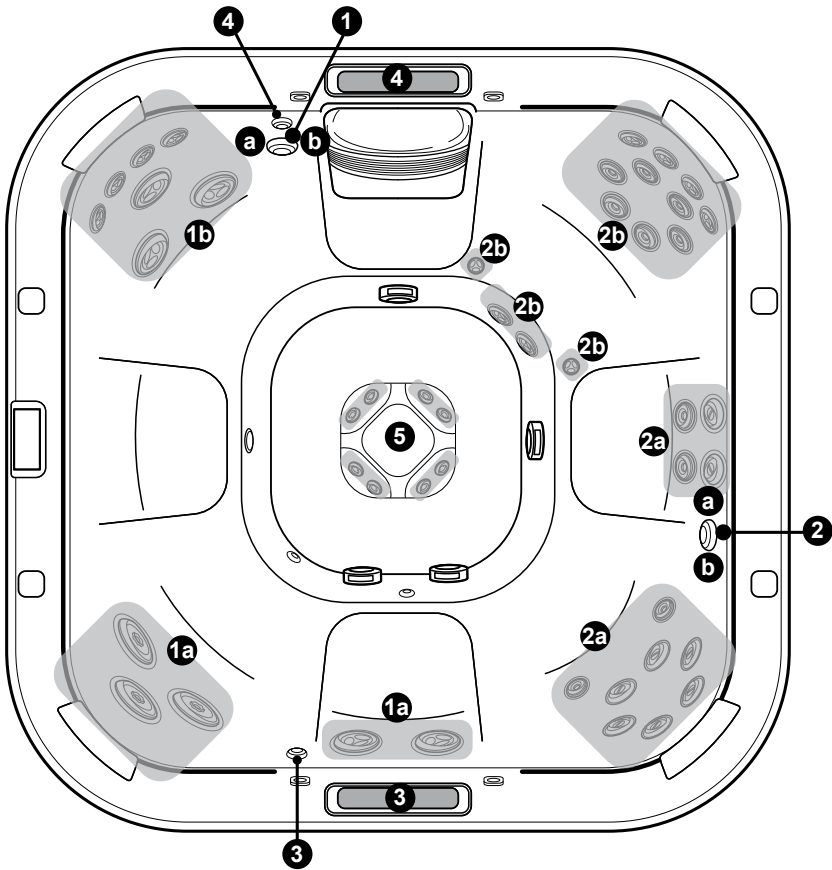

Massage Selectors (1-2)

- *Massage selector 1 diverts jets pump 1 output between jet groups 1a-1b.*
- *Massage selector 2 diverts jets pump 2 output between jet groups 2a-2b.*

Waterfall Selectors (3-4)

- *Waterfall selector (3) controls circulation pump output to waterfall (3).*
- *Waterfall selector (4) controls circulation pump output to waterfall (4).*

Jets Without Massage Selector Controls (5)

- *Jets (5) are always on when jets pump 1 is running.*



Air Controls Operation

- Toggle air controls 1-4 to add air to designated jet groups.

10.0 Registration and Start-up

10.1 Start-up Sequence

During the start-up sequence, the welcome screens will appear, Figure 10.1a. Then a blow out cycle will begin, page 42. After the cycle ends, the hot tub will display the Home Menu.

Note: The start-up menu will time out after approximately 3 seconds.



Figure 10.1a

10.2 Register Your New Spa

Registering your spa is important in order to validate your warranty. In order to register you will need to have the spa serial number, Figure 10.2b, then you will need to register online.

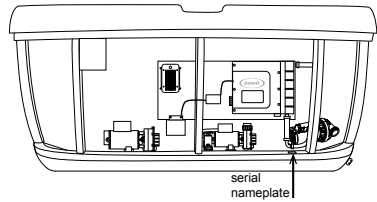

Figure 10.2a

Follow these steps to register your spa.

1. Using your home computer or other device, connect to the internet.
2. Go to www.Jacuzzi.com website to register your spa.
3. Click **Outdoor Hot Tubs**
4. Click **For Owners**
5. Click **Warranty and Manuals**
6. Click **Warranty Registration**
7. Enter your serial number.

Keep a record of your serial number for any future reference. Write that information below.

Serial Number: _____

10.3 ProTouch™ Glass Control Panel

Your Jacuzzi Spa is equipped with a state-of-the-art touch screen control panel. The control panel complements the contemporary and sleek design of your spa. Access to all menus can be achieved by using the touch screen. Programming features can be easily programmed with our user-friendly design. With the ease of use, there will more time to enjoy the benefits of your spa.

A. Home Menu Control Buttons

The Home Menu, Figure 10.3a, provides access to spa functions and programming. Operation is made easy by the interactive touch-screen control panel. If there is no activity for 5 minutes, the LCD display will time-out into a sleep mode. To reactivate the display, just swipe across the top from one corner to the other, Figure 10.3b.

NOTE: When a feature is on, the button will have a blue highlight around it.





Figure 10.3a



Figure 10.3b



Temperature Control: Allows you to adjust the set temperature of the spa:

- Increase the temperature by tapping  in 1°F increments.
- Decrease the temperature by tapping  in 1°F increments.

Note: The temperature range for the spa is 65 to 104°F (18.33 to 40°C). To activate the **Extended Temperature feature** that allows the spa to reach 106°F (41°C), see page 67.



Jet Button: Tap to access the menu to operate the jets pump, page 30.



Light Button: Tap to access the menu to operate the various lighting options, page 31.





Music Button: Tap to access the menu to operate the audio system and settings, page 33.

Note: If the spa does not have the stereo option, there will not be a button on the control panel.



CLEARRAY Button: Tap to activate the CLEARRAY on demand feature, page 36.





-  = **Error Indicator Icon:** Displays when there is error message that needs to be addressed. The icon will also appear under the Temperature reading as a reminder, page 64.
-  = **Invert Button:** Tap to invert the display image.
-  = **Settings Button:** Tap to access the programming and setting menus, page 39.

B. Status Bar

The status bar, Figure 10.3c, is located at the top of the Home Screen menu. When certain components, features or programs are on, their icons are represented within the Status Bar.



Figure 10.3c

- AUTO** = **Heater/Filter Icon:** The current programmed heater/filter setting will appear on the status bar to indicate what heat mode is enabled, page 40.
-  = **Lock Icon:** Displays when one of the lock modes is enabled, page 45.
-  = **Heat ON Icon:** Displays whenever the heater is on and heating the water, page 40.
-  = **CLEARARRAY ON Icon:** Displays when the CLEARARRAY system is enabled, page 36.
-  = **Error Indicator Icon:** Displays when there is error message that needs to be addressed. The icon will also appear under the Temperature reading as a reminder, page 64.
-  = **Wi-Fi Icon:** Displays when there is a Wi-Fi connection. Not applicable if the SmartTub™ system is installed.
- 6:45 PM** = **Time Indicator:** The time will always be shown when the Home Menu is displayed. The appearance will vary depending on whether the clock is set to a 12-Hour or 24-Hour configuration, page 47. The default setting is 12-Hour.

Note: The time does NOT automatically adjust for daylight saving time. The time must be manually adjusted.

11.0 Operating Instructions

11.1 ProTouch™ Glass Control Panel

Your Jacuzzi spa is equipped with a ProTouch Glass control panel; massage selectors, and air control knobs located on the top rim of the spa (pages 21-26). These controls let you operate many of the special functions of your Jacuzzi spa.

11.2 Activating the Jets Pumps

From the Home Menu, (Figure 11.2a), tap  to enter the Jets Pump Submenu. The LCD screen will display the Jets Pump Submenu (Figure 11.2b).

Note: Once you enter the Jets Pump Submenu, all the pumps will activate. You can turn off the jets pump by tapping the jet button 1 or 2.



Figure 11.2a



Figure 11.2b



= **Jets Pump 1 Button**

1



= **Jets Pump 2 Button**

2



= **Back Button:** Tap to go back to the previous menu.



= **Invert Button:** Tap to invert the display image.



= **Setting Button:** Tap to access the programming and setting menus, page 39.

1. Tap the Jets 1 button to turn the pump #1 on and off.
2. Tap the Jets 2 button to turn the pump #2 on and off.



1

2

Note: When a jets pump is on, the button will have a blue highlight.

JETS ICON
WHEN ON

JETS ICON
WHEN OFF

Auto Turn Off — Anytime a pump has been manually turned on, it will automatically turn off after approximately 20 minutes. If at this time you desire more jet operation you may simply turn the pump(s) back on.

11.3 Lights Menu

From the Home Menu, (Figure 11.3a), tap to enter the Light submenus. The LCD screen will display the Light Submenu (Figure 11.3b). From this menu you can control the interior lighting, exterior lighting and experience effect. When you tap to enter the submenus, the lights will turn on, if not on already.

Note: The lights automatically turn off after 2 hours. They can be reactivated if needed.



Figure 11.3a

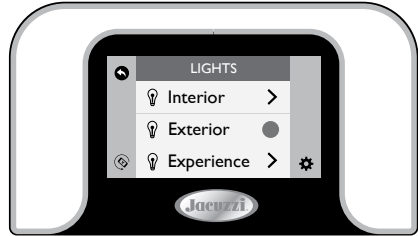

Figure 11.3b



= **Interior Lights Selection:** Tap to enter the Interior Lights Menu.



= **Exterior Lights Selection:** Tap to change the intensity of the Exterior Lights.



= **Experience Mode Selection:** Tap to enter the Experience Mode Menu.



= **Back Button:** Tap to go back to the previous menu.



= **Invert Button:** Tap to invert the display image.



= **Setting Button:** Tap to access the programming and setting menus, page 39.

11.4 Interior Lights

The interior lights consist of the waterfall lighting, above (perimeter lighting) and under (footwell lighting), Figure 11.4a. Each can be independently controlled or they can be controlled in unison. You can control 3 aspects of the interior lights.

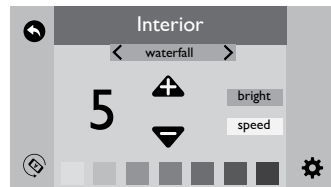



Figure 11.4a

Tap or to scroll through the selections for “Waterfall,” “Above,” “Under” and “All.” If you choose the “All” option, then the lights will work in unison and display the same features and colors.



A. To control the intensity of the interior lights follow the steps below.

1. The “Bright” feature controls the intensity of the interior lights. Use  or  to select your intensity level. The levels range from 5 to 0, as follows: 5 = 100%, 4 = 80%, 3 = 60%, 2 = 40%, 1 = 20% and 0 = 0%. **bright**
Figure 11.4b

Note: The default intensity level is 3.

2. This feature is available for the following selections: “Waterfall,” “Above,” “Under” and “All.”

B. To control the speed of the interior lights follow the steps below.

1. The “Speed” feature controls the speed of the color blending, measured in seconds. Use  or  to select speed rotation. The levels range from 5 to 0, as follows: 5 = 5 secs, 4 = 10 secs, 3 = 15 secs, 2 = 30 secs, 1 = 60 secs and 0 = single color. **speed**
Figure 11.4c

Note: The default speed interval is 0.

2. This feature is available for the following selections: “Waterfall,” “Above,” “Under” and “All.”

C. To select a solid color for the interior lights follow the steps below.





1. To make a selection tap the color block on the display. Colors available are White, Blue, Green, Yellow, Orange, Red, and Pink. 
Figure 11.4d

Note: The default color will always be the last color used.

2. This feature is available for the following selections: “Waterfall,” “Above,” “Under” and “All.”

11.5 Exterior Lights

The exterior corner lighting has 4 settings (Figure 11.5a). The lights display a solid White color only. By continually tapping  you will scroll through the following:

1.  OFF: Exterior lights are turned off.
2.  MID: Solid White color with a 50% intensity level.
3.  ON: Solid White color with a 100% intensity level.
4.  AUTO: Solid White color with a 100% intensity level. Lights are on from 7:00 pm to 12:00 am.

Note: “AUTO” is the default setting.

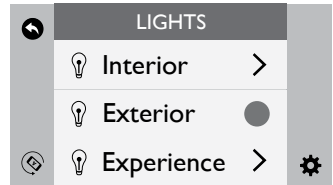

Figure 11.5a

11.6 Experience

The lighting experience can be user enhanced by activating one of the settings below. Just tap one of the words (Quiet, Fun, Glow or Joy) to start the experience, (Figure 11.6a). The default setting is “Glow.”



Figure 11.6a

1. Quiet: All interior lights are a solid Blue color with a 20% intensity level.
2. Fun: All interior lights cycle through all colors with a 100% intensity level and speed of 5.
3. Glow: All interior lights are a solid White color with a 100% intensity level.
4. Joy: All interior lights cycle through all colors with an 80% intensity level and speed of 3.

11.7 Music Menu

Models equipped with the optional Audio System offer an enhanced spa experience. The BLUEWAVE 2.0 Wireless Audio System works with most Bluetooth wireless devices. An auxiliary device can be connected, via a 3.5 mm plug cable, located behind the front cabinet panel, if a Bluetooth device is not available. These models also include four high fidelity spa engineered speakers for unsurpassed sound quality and long-life, and an integrated powered subwoofer for a superb acoustical sound.

Note: If the spa does not have the stereo option, there will not be a button on the control panel.

To access the Music Menu, tap  , Figure 11.7a. The display will change to Figure 11.7b. Once you enter the Music Menu, tap the power button to turn the stereo on. Your connected electronic device, Bluetooth or auxiliary, provides the audio entertainment.



WARNING: RISK OF ELECTRICAL SHOCK HAZARD EXISTS AND EQUIPMENT DAMAGE! Never install or remove electrical devices while hands are wet or while sitting partially immersed or fully immersed in spa!



Figure 11.7a

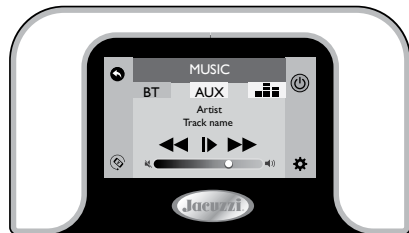

Figure 11.7b



= **Power Button:** Tap to turn the stereo on and off.

BT

= **Bluetooth Settings:** The BT icon cannot be selected manually; a Bluetooth connection must be established with your device.

AUX

= **Auxiliary Settings:** Tap to use your auxiliary device with the stereo. This is the default setting.



= **Audio Settings:** Tap to access the audio submenu.



= **Forward:** Tap to advance forward through tracks.



= **Rewind:** Tap to move back through tracks.



= **Pause/Play:** Tap to pause and play tracks.



= **Volume Slider:** Slide from side to side to increase and decrease the volume level.

Artist
Track Name

= **Artist Track:** Will display the artist and track information, if it is available. If the information is not available this part will be blank. If the information provided is too long, the maximum number of characters will be display follow by dots (“...”).



= **Back Button:** Tap to go back to the previous menu.



= **Invert Button:** Tap to invert the display image.



= **Setting Button:** Tap to access the programming and setting menus, page 39.

If you experience a connection problem with your Bluetooth device, make sure that the Bluetooth antenna is secure and located at the highest point within the equipment bay.

11.8 Bluetooth® Pairing Instructions

A. To pair your Bluetooth® device to the BLUEWAVE®, follow these steps:

1. Tap the music icon on the control panel screen then touch the power button located on the top right to turn on the stereo.
2. From your Bluetooth device, make sure that the Bluetooth setting is ON.
3. Follow the pairing instructions for your Bluetooth device and connect to “BLUEWAVE®” device that appears on your screen.
4. If asked for a password, enter the password “0000” and then connect.
5. If the pairing process is successful, your Bluetooth device will show “Connected” right next to “BLUEWAVE®”.
6. Once the connection is established, Bluetooth “BT” icon on the screen will be highlighted confirming the connection.

Note: The BT icon cannot be selected manually; a Bluetooth connection must be established with your device.

B. Connecting an Auxiliary Device

1. Remove the front panel.
2. Locate the BLUEWAVE unit in the equipment bay.
3. Locate the cable labeled “AUX” that is connected to the unit.
4. Use a 3.5 mm cable (not included) to connect your auxiliary device.
5. Run the cable safely, through the front, and reinstall the panel.

Note: Use caution in handling the auxiliary device, the placement of the device and that the cable is not in the way.

11.9 Audio Settings Menu

To enter the Audio Settings Menu, tap from the Music submenu, Figure 11.9a. The display will change to Figure 11.9b. The Audio Settings menu offers an enhanced audio experience by providing a custom or preset bass and treble settings.

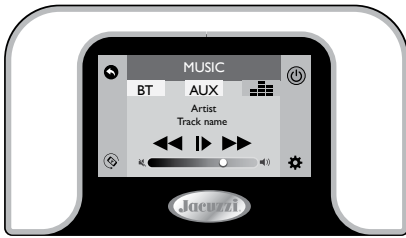

Figure 11.9a



Figure 11.9b



= **Level Adjustment Bars:** Indicates the adjustment level by the number of bars filled.



= **Bass Adjustment:** Slide from side to side to adjust the Bass range from -5 to 5. This feature can be used to create a custom sound.



= **Treble Adjustment:** Slide from side to side to adjust the Treble range from -5 to 5. This feature can be used to create a custom sound.



= **Rock Preset:** Tap **Rock** to activate the “Rock” music audio setting. “Rock” has a 1 Bass and 3 Treble preset setting. When not in use it will be grayed out; if it is in use the button will be highlighted, Figure 11.9b.

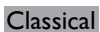

= **Classical Preset:** Tap **Classical** to activate the “Classical” music audio setting. “Classical” has a 1 Bass and 1 Treble preset setting. When not in use it will be grayed out; if it is in use the button will be highlighted, Figure 11.9b.



= **Pop Preset:** Tap **Pop** to activate the “Pop” music audio setting. “Pop” has a -1 Bass and -2 Treble preset setting. When not in use it will be grayed out; if it is in use the button will be highlighted, Figure 11.9b.



= **Back Button:** Tap to go back to the previous menu.



= **Invert Button:** Tap to invert the display image.



= **Setting Button:** Tap to access the programming and setting menus, page 39.

11.10 CLEARRAY on Demand

The CLEARRAY on demand feature activates the water purification system for a period of 1 hour, 2 hours, 3 hours or OFF. Tap  to turn the system on. During this time the circulation pump and the CLEARRAY unit are on. The button will have a blue highlight when this feature is on.

Note: When the CLEARRAY system is on due to a programmed or scheduled setting the feature cannot be turned off.

11.11 Adjusting Jet Flow

The water flow to certain jets in your spa can be increased or decreased by rotating the outside jet face.

Note: Always keep at least 6 adjustable jets open at all times.



11.12 Adjusting PowerPro™ MX2 Jets

Tilt PowerPro MX2 Jet nozzle to angle of choice as desired.

Rotate nozzle clockwise to reduce flow volume from jet or rotate counterclockwise to increase flow volume.

Note: Always keep at least 6 adjustable jets open at all times.



11.13 Adjusting RX Jets

Rotate the outside jet face clockwise to decrease or shut off water flow. Turn counterclockwise to turn on or increase water flow.

Note: Always keep at least 6 adjustable jets open at all times.



11.14 Waterfall Control

Turn waterfall control valve (pages 21-26) from side to side to increase output, decrease output or turn off the waterfalls.

Note: When the waterfall is in the OFF position, some water may still flow through. This is considered normal.



11.15 Air Controls

Certain jet systems have their own air control. Each control introduces air into the water lines that supply that specific jet group (pages 21-26). Simply press any air control button, Jacuzzi logo side down, to open or press the opposite side to button to close. To minimize heat loss, all air controls should be closed when the spa is not in use.

Note: Certain jets may draw air even though they are closed. This is considered normal.





11.16 Selecting the Desired Massage Action

Your Jacuzzi spa is equipped to allow you to customize the massage action you desire. Each model incorporates a massage selector that allows you to customize the massage and performance by diverting water between various jet systems. Simply turn the massage selector to divert water pressure to various jet groups.

Note: It is considered normal for sound levels within the valve to vary between positions due to the large amounts of water flowing through it. For optimum filtration benefits, leave the valve in the center position when the spa is covered.

11.17 Optional BLUEWAVE® 2.0 Wireless Audio System

Jacuzzi models equipped with the optional audio system offer enhanced hot tub enjoyment with an integrated state-of-the-art audio system. These models include an integrated Auxiliary or Bluetooth player receiver, high-quality spa engineered speakers for unsurpassed sound quality and long-life, and a powered subwoofer for an enhanced acoustical experience.

11.18 SmartTub™ System

Advances in technology have allowed us to create a better and smarter hot tub. Our SmartTub™ system operates on a cellular network. The advantages of this system are:

- A more stable connection to internet for outdoor environment. The SmartTub™ device uses much less data than a typical voice connection via cellular networks. We contract through the largest wireless carriers to ensure maximum uptime. The system enables firmware updates via the cell connection so your system's performance will continuously be optimized remotely.
- Maintenance is made easy by alerts sent to your phone.
- Diagnostic alerts are sent to you and your dealer when attention is required.

A. Pairing process

1. Download the SmartTub™ app from the Google Play store or Apple App store.
2. Open the app and create an account.
3. Locate the SmartTub™ sticker next the control panel of the hot tub. You can either scan the QR code with the SmartTub™ app or manually input the serial number located below the QR code on the sticker.
4. After you pair the hot tub's serial number to the SmartTub™ app, the app will load and connect the hot tub to the internet.
5. Follow the instructions on the app to begin enjoying the benefits of your internet connected hot tub.

Note: The first year of data service is included. You will need to renew the subscription after the first year. Please refer to the terms of service and privacy policy links in the SmartTub™ app for additional information.

B. Indicator Lights

There are indicator lights on the SmartTub™ controller that relay the status of the system. Below are meanings of the lights.

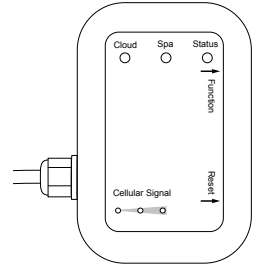

1. Cloud:
 - Blue light on - connected to cloud.
 - Blue light off - not connected to cloud.

2. Spa:
 - Blue light on - connected to spa controller
 - Blue light off - not connected to spa controller

3. Status:
 - Cyan light - breathing (slow pulsing) indicates the status is good.
 - Cyan light - flashing indicates that the system is completing a connection to the cloud.
 - Green light - flashing indicates waiting for a connection to the cellular tower.
 - Dark blue light - flashing indicates a SIM error.

4. Cell signal strength:
 - 3 blue LED lights indicates cell signal strength.

C. Resetting the SmartTub™ controller

Should the SmartTub™ controller need to be reset, hold the magnet (located on the cord) to the reset label on the side of the SmartTub device.

12.0 Programming Instructions

Your Jacuzzi spa is equipped with setting menus that allow you to program and activate different components of the spa. With our ProTouch™ Glass control panel, programming your spa has never been easier. In the sections that follow, we will guide you through the process of programming the spa to fit your personal comfort.

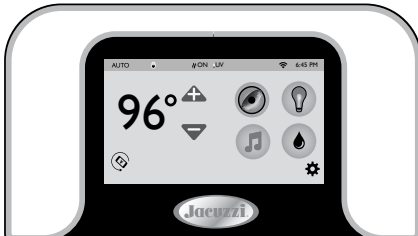

Figure 12.0a



Figure 12.0b

- Heat & Filter** = **Heat and Filter:** Tap to access the heating and filtration programming, page 40.
- Water Care** = **Water Care:** Tap to access the water care programming, page 43.
- Lock** = **Lock:** Tap to access the locking programming, page 45.
- Time & Date** = **Time and Date:** Tap to access the time and date programming, page 47.
- Language** = **Language:** Tap access the language programming, page 47.
- Units** = **Units:** Tap either or for the temperature display. Default setting is .
- WiFi** = **Wi-Fi:** Tap to access the Wi-Fi programming, page 48. Not applicable if the SmartTub™ system is installed.
- = **Back Button:** Tap to go back to the previous menu.
- = **Invert Button:** Tap to invert the display image.

12.1 Programming the Heating Mode

Your Jacuzzi spa is equipped with 3 modes of heating, Figure 12.1a. An automatic mode called “Auto,” where the spa’s temperature is maintained at all times. An energy saving heating cycle called “Econo.” A mode that will only activate the heater during the daytime called “Day” mode.

Note: The heater will activate when the temperature drops 2°F from the set temperature.

● Indicates that the feature is active. ● Indicates that the feature is not active.

A. Auto heating:

1. When programmed to “Auto,” the spa will maintain the water temperature to the set temperature. Heating will occur when necessary.
2. To select this mode, tap ● next to the “Auto” icon.

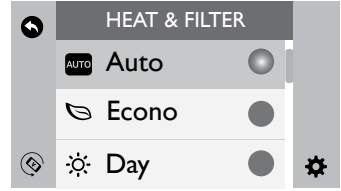

Figure 12.1a

B. Econo heating:

1. This is an energy saving heating program that allows the spa to heat during non-peak hours. When programmed to “Econo,” the spa will only be allowed to heat the water between 5:00 PM to 7:00 AM every day of the week. The hours cannot be adjusted.
2. To select this mode, tap ● next to the “Econo” icon.

C. Day heating:

1. When programmed to “Day,” the spa will only be allowed to heat the water between 7:00 AM to 5:00 PM every day of the week. The hours cannot be adjusted.
2. To select this mode, tap ● next to the “Day” icon.

12.2 Programming the Primary Filter

To access the “Primary Filter” feature, you need to scroll down to the “Heat & Filter” menu, Figure 12.2a and 12.2b. Once you scroll down, tap > to enter the “Primary Filter” programming, Figure 12.2c.

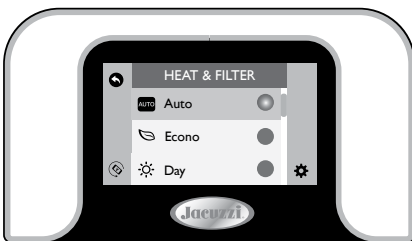

Figure 12.2a

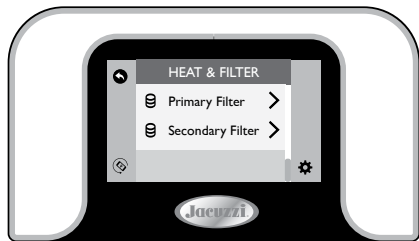

Figure 12.2b

During a primary filtration, the circulation pump, CLEARRAY and ozone unit (if applicable) are activated. The factory default cycle starts at 12:00 AM and last for 8 hours. If you elect to keep this setting, then you can skip this section.



In extreme bitter cold weather we recommend you program the circulation pump to run 24 hours. Refer to the "Winterizing" section on page 57.

Any time the circulation pump runs outside of a program cycle, e.g. for heating, that run time will be deducted from the next primary filter cycle. For example, the primary filter cycle is set to 8 hours every 24 hours but the circulation pump comes on for 2 hours to heat the water after the cycle has finished. The next primary filter cycle will only be for 6 hours not 8 hours.

A. To change the default cycle (the adjustments are made in 1-hour increments):

1. Tap **Start** to program the start time for the cycle.
2. Slide your finger up and down to roll the time scroll wheels to adjust the start time.
3. Tap **End** to program the end time for the cycle.
4. Slide your finger up and down to roll the time scroll wheels to adjust the end time.
5. Tap **Set** to save and accept the changes.

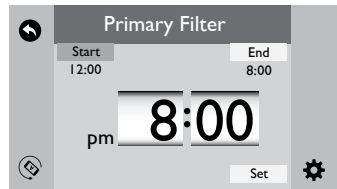

Figure 12.2c

Summer Logic: In warm weather, the water temperature in the spa may exceed the set temperature. This condition may occur due to heat transference from the filter/circulation pump and jets pumps. If the water temperature is higher than 95°F (35°C) and rises 2°F above the set temperature, a "Summer Logic" condition occurs that deactivates the filter/circulation pump and CLEARRAY®. This safety feature cannot be altered! The filter/circulation pump and CLEARRAY® will remain off until the water temperature cools to the set temperature (except when the filter/circulation pump runs for it's mandatory 3-hour cycles between 8am-11am and 8pm-11pm.) To help prevent a "Summer Logic" condition, it may be necessary to reduce filter/circulation pump cycles run times in warm weather.

12.3 Programming the Secondary Filter

To enter the Secondary Filter program, tap **>** from the heat and filter menu, Figure 12.2b. The display will change to Figure 12.3a. During a secondary filtration, the Jets Pump 1 is activated. There are 3 cycles you can select from, Figure 12.3a. The factory default cycle is “Away Mode.” If you elect to keep this setting, then you can skip this section.

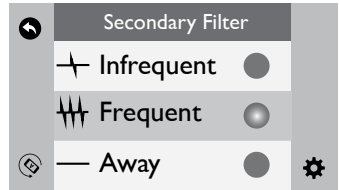

Figure 12.3a

● Indicates that the feature is active. ● Indicates that the feature is not active.

A. To change the Secondary Filter cycle:

1. **Away Mode:** Secondary Filtration is disabled. To activate this mode, tap ● next to the “Away” icon.

Note: This is the factory default setting.

2. **Infrequent Mode:** Activates two cycles at 8:00 PM and 8:00AM **every other day**. Each cycle will last 10 minutes for a total of 20 minutes every other day. To activate this mode, tap ● next to the “Infrequent” icon. Time and duration cannot be altered.

3. **Frequent Mode:** Activates two cycles at 8:00 PM and 8:00AM **every day**. Each cycle will last 10 minutes for a total of 20 minutes every day. To activate this mode, tap ● next to the “Frequent” icon. Time and duration cannot be altered.

12.4 Clean up Cycle

The clean up cycle occurs once per day at 12:00 pm (noon) for two minutes. This is not user programmable. The Jets Pump 1 and the Circulation Pump will turn on for one minute and then shut off. Then Jets Pump 2 will turn on and run for 1 minute then shut off. Turning off the corresponding jets pump, that is running, can deactivate the feature.

12.5 Blow-Out Cycle

This cycle will purge the air from the plumbing lines normally caused by draining and filling the spa. The Jets Pump 1 and the Circulation Pump will turn on for 1 minute and then shut off. Then Jets Pump 2 will turn on and run for 1 minute then shut off. Turning off the corresponding jets pump, that is running, can deactivate the feature. This cycle will **only** occur:

- At start up.
- After exiting a service lock.

12.6 Water Care Programming

Water care is crucial to maintaining a healthy and clean spa. The CLEARRAY water purification system leads the way by sanitizing the water using a UV light bulb. Your spa can be programmed to remind you when to check and replace certain components.

From the “Settings” menu, tap > next to “Water Care” to enter the programming options, Figures 12.6a and 12.6b.

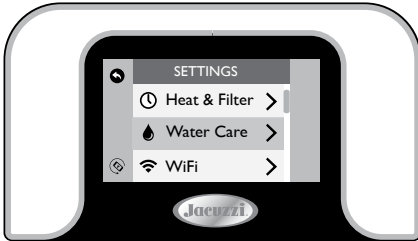

Figure 12.6a



Figure 12.6b

A. Programming the CLEARRAY UV Bulb Timer

The CLEARRAY UV bulb has a life expectancy of 1-year. A timer activates when power is applied and begins a countdown starting at 365 days. Once the timer expires, an error message will appear on the display, the UV bulb must be replaced and the timer needs to be reset.

1. When you enter the “Water Care” Menu, Figure 12.6c, you will be able to set the CLEARRAY UV bulb timer.
2. Slide your finger up and down to roll the days scroll wheel to adjust the number of days from OFF to 365. The adjustments are made in increments of 10 days. The CLEARRAY UV timer counts down by days not usage. The days are stored in memory if the power is interrupted.



Figure 12.6c

Note: It is not recommended that this feature be turned OFF. In order to continually have the CLEARRAY system effectively perform its function, it should be programmed as instructed.

3. Tap **Set** to confirm and save your changes.
4. When the timer expires, a message will appear on the control panel display, page 66. The CLEARRAY UV bulb **must be replaced** (page 61) and the timer must be reset. Tap “reset” and follow the instructions above to reset the timer. If you tap “snooze” the message will clear but the error icon will display and the reminder screen will reappear in 10 days.

B. Programming the ProClarity/ProClear Filter Timer

A programmable filter timer can be set to remind you when to clean or replace the filters and skimmer bag.

1. When you enter the “Water Care” Menu, Figure 12.6c, tap < or > until you reach the “ProClarity” option, Figure 12.6d.
2. Slide your finger up and down to roll the days scroll wheel to adjust the number of days from OFF to 180. The adjustments are made in increments of 10 days. The

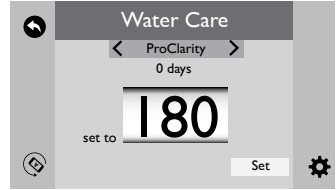

Figure 12.6d

Note: It is not recommended that this feature be turned OFF. In order to continually maintain clean and working filters, it should be program as instructed.

3. Tap **Set** to confirm and save your changes.
4. When the timer expires, a message will appear on the control panel display, page 67. The filters must be cleaned or replaced. Follow the instructions above to reset the timer. If you tap “snooze” the message will clear but the error icon ▲ will display and the reminder screen will reappear in 10 days. Refer to Section 13.1, page 50, for cleaning instructions.

C. Programming the ProClarity Depth Filter Timer

A programmable filter timer can be set to remind you when to replace the ProClarity Depth Filter.

1. When you enter the “Water Care” Menu, Figure 12.6d, tap < or > until you reach the “ProClarity Depth” option, Figure 12.6e.
2. Slide your finger up and down to roll the days scroll wheel to adjust the number of days from OFF to 90. The adjustments are made in increments of 10 days. The days are stored in memory if the power is interrupted.

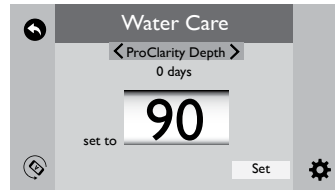

Figure 12.6e

Note: It is not recommended that this feature be turned OFF. In order to continually maintain clean and working filters, it should be program as instructed.

3. Tap **Set** to confirm and save your changes.
4. When the timer expires, a message will appear on the control panel display, page 67. Follow the previous instructions to reset the timer. The filter must be replaced. Refer to Section 13.1, page 50, for filter location. If you tap “snooze” the message will clear but the error icon ▲ will display and the reminder screen will reappear in 10 days.

D. Programming the Water Change Timer

A programmable “Water Refresh” reminder can be set to remind you when to drain and refill the spa.

1. While in the “Water Care” Menu, Figure 12.6e, tap < or > until you reach the “Water Change” option, Figure 12.6f.
2. Slide your finger up and down to roll the days scroll wheel to adjust the number of days from OFF to 180. The adjustments are made in increments of 30 days. The days are stored in memory if the power is interrupted.



Figure 12.6f

Note: It is not recommended that this feature be turned OFF. In order to continually maintain the water healthy and clean, in addition to chemical maintenance, it should be program as instructed.

3. Tap **Set** to confirm and save your changes.
4. When the timer expires, a message will appear on the control panel display, page 67. The water must be drained and replaced with fresh water. Follow the instructions above to reset the timer. If you tap “snooze” the message will clear but the error icon will display and the reminder screen will reappear in 10 days. Refer to Section 13.1, page 50, for filter location.

12.7 Locking the Spa

From the “Settings” menu, tap > next to “Lock” to enter the programming options, Figures 12.7a and 12.7b. You can prevent users from changing certain features of the spa. When a lock feature is active, the lock icon will appear of the status bar. When you enter the “Lock” menu, if one of the three settings is active, it will be highlighted orange.

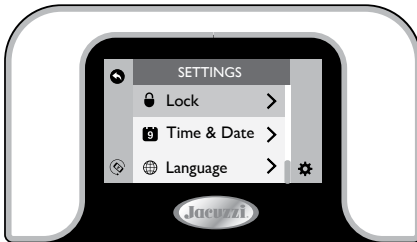

Figure 12.7a

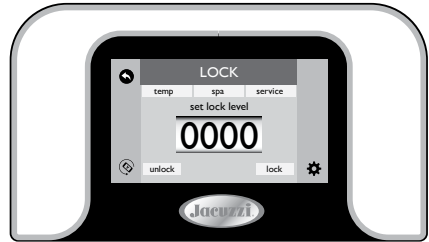

Figure 12.7b

A. Temp Lock:



1. Tap **Temp** to lock the temperature feature, Figure 12.7c.
2. Use the scroll wheel **0000** to assign a 4-digit lock and unlock code by sliding your finger to change the numbers.
3. Tap **lock** to activate the locking feature.
4. The adjust temperature feature is disabled, but the spa will still perform all scheduled tasks.
5. Tap  to return to the Settings Menu.



Figure 12.7c

B. Spa Lock:

1. Tap **Spa** to lock the spa, Figure 12.7c.
2. Use the scroll wheel **0000** to assign a 4-digit lock and unlock code by sliding your finger to change the numbers.
3. Tap **lock** to activate the locking feature.
4. All activation and adjustment features are disabled but the spa will still perform all scheduled tasks.
5. Tap  to return to the Settings Menu.

C. Service Lock:

1. Tap **Service** to lock the spa, Figure 12.7c.
2. Use the scroll wheel **0000** to assign a 4-digit lock and unlock code by sliding your finger to change the numbers.
3. Tap **lock** to activate the locking feature.
4. All spa functions are locked to allow for a temporary service mode for filter cleaning.
5. Tap  to return to the Settings Menu.
6. When you exit this lock mode, a blow out cycle will start, page 42.

Note: This mode has a time out of 2 hours. The spa should not be left in this lock mode for an extended period. Especially in colder climate or when freezing conditions exist.

D. To Unlock (Figure 12.7c):

1. Enter the Lock menu. The type of lock that is active will already be highlighted.
2. Tap **0000** (the first block) to start entering the code. Then move on to the next number until the four-digit unlock code has been entered.
3. Tap **unlock** to unlock.
4. Tap  to exit the menu.

Note: A default passcode can be used in case the original passcode is lost or forgotten. The code “0772” will unlock the locked setting.

12.8 Programming the Time and Date

From the “Settings” menu, tap **>** next to “Time & Date” to enter the programming options, Figures 12.8a and 12.8b.

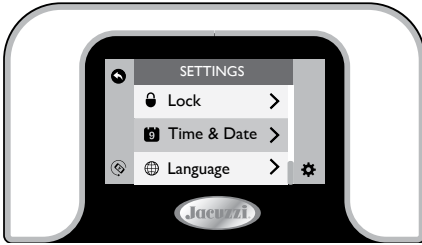

Figure 12.8a



Figure 12.8b

A. To set the time and date:

1. Tap **Time** to program the time, Figure 12.8c.
2. Slide your finger up and down to roll the time scroll wheels to adjust the time. The “am” and “pm” will adjust according as the time is changed.
3. Tap **Date** to program the date, Figure 12.8d.
4. Slide your finger up and down to roll the date scroll wheels to adjust the date. Each setting for month, day and year can be set independently.
5. The default time setting is a 12-hour configuration. To choose the 24-hour configuration, then tap **24**, Figure 12.8d, to change the setting.
6. Tap **Set** to save and accept the changes.

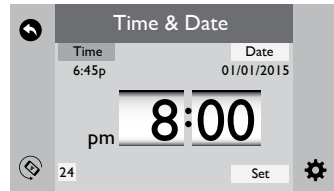

Figure 12.8c

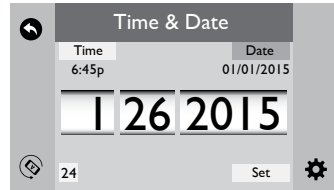

Figure 12.8d

12.9 Programming the Language

From the “Settings” menu, tap **>** next to “Language” to enter the language options, Figures 12.9a and 12.9b.

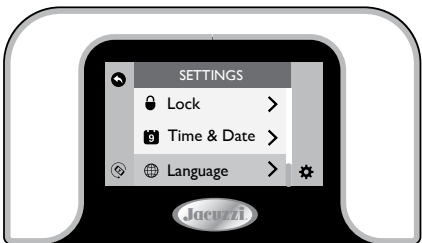

Figure 12.9a



Figure 12.9b

Indicates that the feature is active. Indicates that the feature is not active.

1. There are 4 languages to select from: English, French, Deutsch, and Spanish. To view the selections, use the scroll wheel to move up and down. To select a language, tap ● next to the language you want to display, Figure 12.9c.

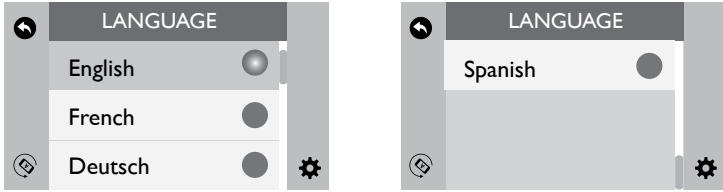

Figure 12.9c

12.10 Wi-Fi Setup (not applicable if the SmartTub™ system is installed)

Connecting to your home Wi-Fi network. From the “Settings” menu, tap > next to “Wi-Fi” to enter the programming options, Figures 12.10a and 12.10b. Make sure you have downloaded the Wi-Fi App for this setup.

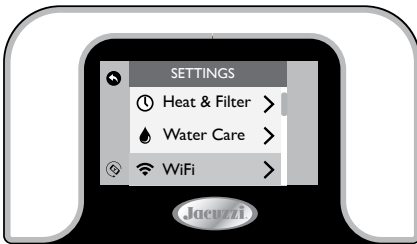

Figure 12.10a



Figure 12.10b

1. You need to follow the instructions from the App in order to connect the Wi-Fi.
2. While the system attempts to connect you will see the, “Spa Wi-Fi Setup in-progress,” Figure 12.10b. When the connection is done the display will read, “Spa Wi-Fi Setup Connection Success,” Figure 12.10c.

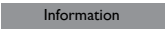

Figure 12.10c

If the Wi-Fi connection should need to be updated or connected to a new router, follow the steps below.

1. From the “Settings” menu, tap > next to “Wi-Fi” to enter the menu.
2. Tap **Reset?**. The display will change to “Spa Wi-Fi Setup In-progress” and the reset button will be highlighted in orange.
3. Tap **Reset?** again. This will clear the current data and allow the spa to connect to the new data.
4. Reconfigure and setup your spa by following the instructions from the app.

12.11 System Information

This menu will display the current information for the spa. From the Settings Menu, tap  to enter the selection menu, Figure 12.11a. There are no selections that can be made. The menu simply provides information.

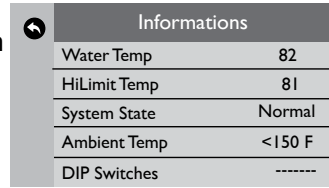

Informations	
Water Temp	82
HiLimit Temp	81
System State	Normal
Ambient Temp	<150 F
DIP Switches	-----

Figure 12.11a

13.0 Spa Maintenance

Proper and regular maintenance of your spa will help it retain its beauty and performance. Your authorized Jacuzzi dealer can supply you with all the information, supplies, and accessory products you will need to accomplish this.



DANGER: RISK OF SEVERE INJURY OR DROWNING BY ENTRAPMENT!

- Keep hair, loose articles of clothing or hanging jewelry away from suction fittings, rotating jets or other moving components to avoid entrapment that could lead to drowning or severe injury.
- Never use the spa unless all suction guards, filter, filter lid, or skimmer assembly are installed to prevent body and/or hair entrapment.
- Never operate or use the spa if the filter, filter lid, or skimmer assembly are broken or any part of the skimmer assembly is missing. Please contact your dealer or nearest service center for service.
- The suction fittings and suction covers in this spa are sized to match the specific water flow created by the pump(s). If it is necessary to replace the suction fittings, suction covers or pump(s), be sure that the flow rates are compatible and are in compliance with the VGB Safety Act, page 2.
- Never replace a suction fitting or suction cover with one rated less than the flow rate marked on the original suction fitting. Using improper suction fittings or suction covers can create a body or hair suction entrapment hazard that may lead to drowning or severe injury.
- Owners must alert all spa users to the potential risk of Hair, Limb, Body, Evisceration (disembowelment), and Mechanical Entrapment, page 7.

13.1 Cleaning the Filter Cartridges

A reminder message appears on the control panel display after a specified number days to remind you to clean the skimmer filter and to check the polishing bag filter. This reminder must be reset at each filter cleaning interval. Refer to Section 12.6

(page 44) for additional information and programming details. Your new spa is equipped with an advanced 2-Stage filtration system. Fine debris are filtered by the circulation pump drawing water through the ProClarity™/ProClear™ skimmer and pleated filter cartridges 8 hours (unless programmed otherwise). Large debris are filtered when jets pump 1 is running when the spa is in use or during a programmed filter cycle. These pumps draw water from footwell suction fitting and through a secondary water polishing bag filter and additional filter.



Reminder

It's time to clean or replace your ProClarity and ProClear filters. Contact your authorized dealer if new filters are needed.

A. Cleaning the filters and filter bag

To ensure optimum performance

1. The ProClarity™ filter cartridge (A) must be cleaned every month and replaced every 18 months.
2. The ProClarity Depth filter (B) must be replaced every 3 months.
3. The ProClarity filter canister (C) can be rinsed when the filters are cleaned.
4. The ProClear II skimming filter cartridge (D) must be cleaned every month and replaced every 18 months.
5. The ProClarity debris bag (E) should be checked and emptied monthly.

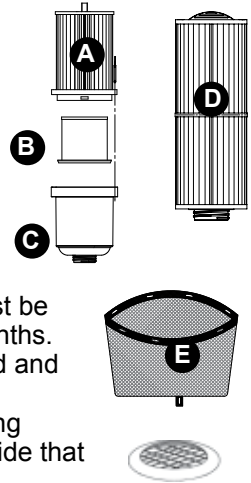

To accomplish this, refer to the following filter cleaning procedure. The primary filter cartridge goes on the side that has the wall fitting with the grid, Figure 13.1b.

Note: Do not attempt to wash the ProClarity depth filter (B) and the ProClear/ProClarity debris bag (E) or it will come apart!

B. Cleaning the Filters/Debris bag:

⚠ A DANGER: TURN POWER TO SPA OFF! TO DECREASE RISK OF DEATH, DROWNING, OR ENTRAPMENT, NEVER OPERATE SPA WHEN FILTER IS NOT PROPERLY INSTALLED OR IF SKIMMER ASSEMBLY IS DAMAGED OR ALTERED! ⚠

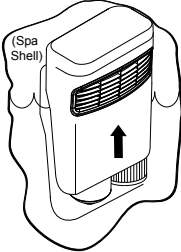
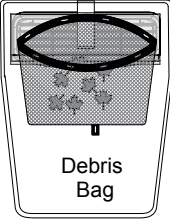
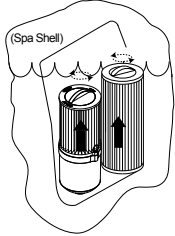
<p>B</p>  <p>Lift the cover upward to access filter cartridges.</p>	<p>C</p>  <p>Remove the ProClarity debris bag from clips and then clean out debris.</p>	<p>D</p>  <p>Rotate each filter cartridge handle counterclockwise to unthread from mating wall fitting.</p>
--	--	--

E

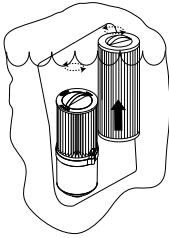

Lift unthreaded filter cartridge from skimmer well.

F

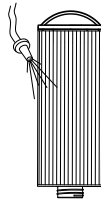

Cartridge 1

If used, remove the chemical feeder as instructed prior to rinsing the filter cartridge. Rinse debris from filter pleats using a garden hose and high-pressure nozzle. Start at the top and work downward towards handle. Repeat until all pleats are clean.

G

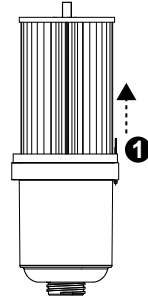

Remove the filter pin **1** in order to separate the ProClarity filter and canister.

H

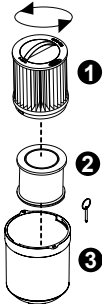

Once the filter pin is removed, rotate the filter cartridge handle counterclockwise to unthread from the filter canister. You can clean the filter **1** and canister **3**, but you must replace the ProClarity Depth Filter **2** every 3 months.

I

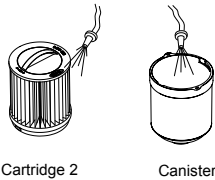

Rinse debris from filter pleats using a garden hose and high-pressure nozzle. Start at the top and work downward towards handle. Repeat until all pleats are clean. Rinse out any debris from the canister.

J

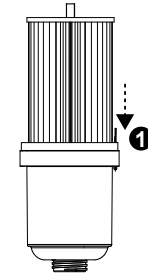

Reassemble the ProClarity Filter. Remember to replace the depth filter with a new one. Once the filter is assembled, secure it with the filter pin **1**.

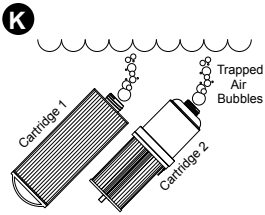

Submerge both filter cartridges in spa. Tilt threaded end upward to remove trapped air bubbles, then keep cartridges submerged to prevent air entrapment during installation.

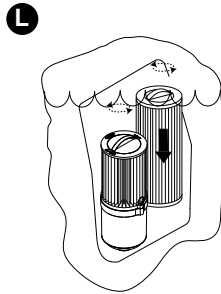

Place each cartridge back into skimmer well, then rotated each cartridge handle clockwise to thread back into wall fitting. **DO NOT OVERTIGHTEN!**

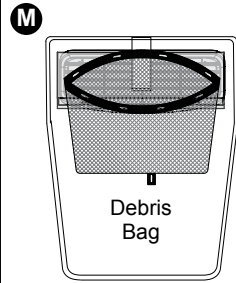

Install clean debris bag back onto the filter cover clips as shown (you can flip the filter skimmer and use the back side to extend usage).

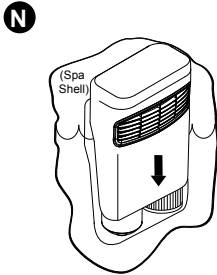

Reinstall the skimmer shield over the filters. Then turn power to spa back on.

Note: Primary filter fitting is the one with the grid.

13.2 Draining and Refilling

About every 3 months, you will want to replace the spa's water. The frequency depends on a number of variables including the amount of use, number of users, attention paid to water quality maintenance, etc. During this time, it is also recommended that you use Jacuzzi's Jet Line Cleaner to clean the internal plumbing lines from buildup and debris. Note: Jacuzzi chemicals are for use in the U.S. only.

CAUTION! READ THIS BEFORE DRAINING: To prevent damage to the spa components, turn off power to the spa at the circuit breaker before draining it. Do not turn the power back on until your spa has been refilled.

CAUTION: There are certain precautions to keep in mind when draining your spa. If it is extremely cold, and the spa is outdoors, freezing could occur in the lines or the equipment (see "WINTERIZING," page 57). On the other hand, if it is hot outdoors, do not leave the spa's surface exposed to direct sunlight.

A. To drain your spa, perform the following steps (standard drain):

1. Turn off power to spa at breaker.
2. Locate the drain valve located on the front left corner on the black plastic pan. Hold the larger (rear) drain valve body to prevent it from turning, then loosen and remove the front cap to expose the underlying male hose threads, Figure 13.2a.
3. Attach a garden hose to the exposed threads, Figure 13.2b.
4. Gently rotate the larger (rear) valve body 1/3 turn counterclockwise to unlock the drain valve, Figure 13.2c.
5. Pull the larger (rear) body outward as shown to open drain, Figure 13.2d.
6. After the spa drains, perform steps 2-5 in reverse order to close the drain prior to refilling spa.

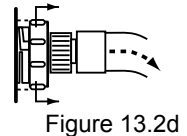
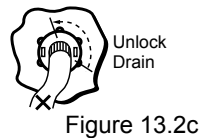
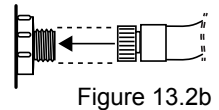
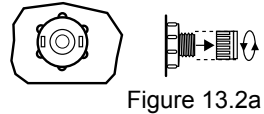

After refilling, turn on power to the spa and follow the steps listed under "Spa Fill Up Procedures" (page 16). If an airlock occurs, see troubleshooting section page 68.

B. To drain your spa, perform the following steps (QuickDrain):

1. Turn off power to hot tub at the breaker.
2. You must first remove the corner panels in order to remove the center panel, Figure 13.2e.

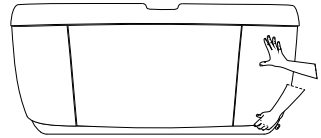

Figure 13.2e

3. Grab one of the corner panels, from the bottom, where it touches the bottom pan. Then gently pull the panel forward to unsnap it from the holding clip. Place the corner panel in a safe location to prevent from damaging it. Repeat the steps to remove the other corner panel.

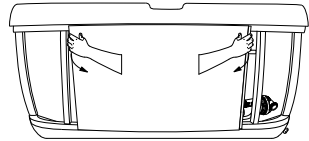

Figure 13.2f

4. Now you need to remove the center panel. Grab the sides of the panel and gently pull the cabinet forward until all the clips have been release then pull up to remove, Figure 13.2f. Place the panel in a safe location to prevent from damaging it.

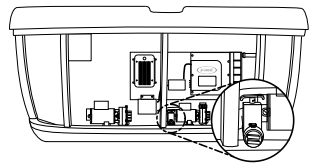

Figure 13.2g

5. Locate the QuickDrain valve, Figure 13.2g.
6. Unscrew drain valve cap, Figure 13.2h. Place the cap aside.

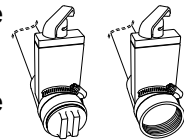

Figure 13.2h

7. Screw in the adapter with hose that was included in the equipment bay; attach it to the QuickDrain, Figure 13.2i. Make sure to direct the hose to an area where the water will drain properly.

8. Open the drain slice valve by sliding the handle to the side and pulling up.

9. After the hot tub has drained close the slice valve by pushing it downward and sliding the handle to the side. Remove the adapter and reinstall the QuickDrain cap before refilling hot tub.

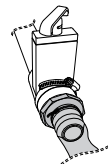

Figure 13.2i

After refilling, turn on power to the spa and follow the steps listed under “Spa Fill Up Procedures” (page 16). If an airlock occurs, see troubleshooting section page 68.

13.3 Cleaning the Spa Interior

To preserve the sheen of your spa’s surface, it is crucial that you avoid using abrasive cleaners or cleaners which have adverse chemical effect on the surface. If you are not certain as to the suitability of a particular cleanser, consult your authorized Jacuzzi dealer. We recommend using Jacuzzi’s Spa All Purpose Cleaner to clean the spa’s interior surface. Use extreme care to assure that no soap residue is left on the surface. This could cause severe sudsing when the spa is refilled. Jacuzzi chemicals are for use in the U.S. only.

13.4 Pillow Care

Clean the headrests in your spa as needed by wiping them with a cloth with soapy water. It is not necessary to remove the headrests for cleaning. To remove headrests for long-term storage or replacement, grasp both ends of each headrest and gently pull inward towards the center of the spa. To reinstall, over mounting strip and press down until headrest mounting bracket emits a “click” sound.

13.5 Maintaining the Synthetic Cabinet

The synthetic cabinet requires little or no maintenance of any kind. To clean, simply wipe cabinet with mild detergent soap solution and a clean towel.



CAUTION: Never spray cabinet with a high pressure garden hose for any reason since this action may induce an electrical short in the spa’s electrical equipment.

13.6 Cleaning the Control Panel

To clean, simply wipe control panel with a micro-fiber cloth that is used for cleaning polycarbonate lenses.

13.7 Cover Care and Maintenance

Certain hot tub covers distributed by Jacuzzi Hot Tubs have a vinyl or PROLAST™/PROLAST™ Extreme encasement. This vinyl or PROLAST™/PROLAST™ Extreme encasement also referred to as the cover “skin” is attractive and durable. Regular monthly cleaning and conditioning (vinyl) is strongly recommended and may increase the longevity of your cover. Jacuzzi chemicals are for use in the U.S. only.

A. To Clean and Condition the Cover

1. Use a garden hose to loosen debris and dirt.
2. Using a large sponge or a soft bristle brush, use diluted or mild soap and scrub the vinyl top.
3. Rinse clean and do not allow soap to dry on cover. Do not use soap on the underside of the cover.
4. Please check with your Jacuzzi Dealer about purchasing Jacuzzi’s cover care and conditioning products. Condition using non-petroleum based conditioners to keep the vinyl supple and threads/stitching from drying out.
5. Do not use solvents, abrasive cleaners or strong detergents. Do not use products that contain silicone or alcohol.

B. Additional Care and Maintenance Instructions:

1. Debris can accumulate on the spa cover. Removal of snow or other debris will help to avoid breakage of the foam cores.
2. Be sure to lock the cover straps to secure the cover from unwanted or accidental entry.
3. Do not place heavy objects on the vinyl.
4. Do not walk, sit or stand on the cover.

5. Do not drag or use the flaps/skirt or the cover lock straps to remove the cover.
6. Use only recommended cover lift systems.
7. Use only chemicals and cleaners recommended by Jacuzzi.
8. Remember to keep spa covered when not in use. Maintaining proper water levels assures efficient operation and efficient electrical usage.
9. Do not expose your spa to the sun for extended periods of time as UV rays can damage the interior surface.
10. Use caution when removing cover. Before removing cover, assure all locks have been released to avoid lock breakage and or cover strap damage.

13.8 Winterizing

Your Jacuzzi spa is designed to automatically protect itself against freezing when operating properly. During periods of severe freezing temperatures, you should check periodically to be certain that the electrical supply to the spa has not been interrupted. In extreme, bitter cold weather (less than 0°C) we recommend that the circulation pump is set for 24-Hour operation (Section 12.2 Programming The Primary Filter Cycle, page 40) and that auto-heating is selected (Section 12.1 Auto-Heating, page 40) to protect against damage to the spa.

If you do not intend to use your spa, or if there is a prolonged power outage during periods of severe freezing temperatures, **it is important that all water be removed from the spa and equipment to protect against damage from freezing.**

Expert winterization of your spa is highly recommended; contact your authorized Jacuzzi dealer. In emergency situations, taking the following steps can minimize damage:

CAUTION: TURN OFF POWER TO SPA.

1. Follow the directions on page 54 for draining the spa.
2. Turn the massage/diverter selector(s) into the middle combo position to allow the water in the plumbing lines to drain, page 37.
3. Turn the waterfall valve to the open position to allow the water in the plumbing lines to drain, page 36.
4. As the water level drops below the seats, use whatever means necessary to get the water out of the recessed seating areas and into the footwell, such as a wet/dry vacuum.
5. Open all the air controls and leave them open until you resume use of the spa, page 36.
6. When the water level ceases to drop, use whatever means available to remove any remaining water from the footwell, such as a wet/dry vacuum.
7. Remove the equipment-side cabinet panels and locate the drain plugs in the front of each pump (Figure A, page 14). Remove these plugs to allow the water to drain out of the pumps and heater.

Note: Approximately one to two gallons will be released during this procedure. Use a wet/dry vacuum or other means to keep this from flooding the equipment compartment. Replace the drain plugs.

8. Loosen hose clamp at bottom of heater (Figure A, page 14) and pull hose off of heater fitting (twist the hose back and forth while pulling downward). Tip hose down and allow it to drain and then reinstall hose and clamp.
9. Loosen the hose clamp on the circulation pump (if equipped) intake behind the control box (Figure A, page 14) and pull the hose off (twist hose back and forth while pulling outward). Tip hose down and allow it to drain and then reinstall hose and clamp.
10. Loosen hose clamp at bottom of CLEARRAY® system and pull hose off of CLEARRAY fitting (twist the hose back and forth while pulling downward). Tip hose down and allow to drain. Then reinstall hose and clamp. Remove the cover of the CLEARRAY system to access the UV bulb and quartz tube. Remove and store the UV bulb in a safe location. Remove and dry off the quartz tube then reinstall it. Depending on the length of time, consider replacing the UV bulb when you resume use of your hot tub.
11. Re-install cabinet side panels and cover spa so that no casual moisture can enter into it.

Consult your Jacuzzi dealer if you have any questions regarding winter use or winterizing.

13.9 Restarting Your Spa in Cold Weather

If you want to start up your spa after it has sat empty for a time in freezing temperatures, be aware that the water remaining in certain Sections of the piping may still be frozen. This situation will block water flow preventing the spa from operating properly and possibly damaging the equipment. We recommend you consult your dealer for guidance before attempting to restart your spa under these conditions.

14.0 Water Quality Maintenance

To decrease the risk of contracting a waterborne illness (e.g. an infection, bacteria or virus) and/or respiratory ailments, maintain water quality within specified limits. This will enhance your enjoyment and prolong the life of the hot tub's equipment. Doing so requires regular attention because the water chemistry involved is a balance of several factors. Procrastination in regard to water maintenance will result in poor and potentially unhealthful conditions for soaking and even damage to your hot tub investment. For specific guidance, on maintaining water quality, consult your authorized Jacuzzi dealer who can recommend the appropriate Jacuzzi chemical products. Jacuzzi chemicals are for use in the U.S. only.

**WARNING: FAILURE TO MAINTAIN WATER QUALITY WILL:**

- Increase risk of contracting a waterborne illness (e.g. an infection bacteria or virus) and/or respiratory ailments.
- Damage the equipment, components and spa shell, which are not covered under the hot tub's warranty.

CAUTION: Never store hot tub chemicals inside the hot tub's equipment bay. The equipment bay may reach elevated temperatures, this is where high voltage electronic devices are located. This area is not intended for storage of any kind.

14.1 pH Control

pH is a measure of relative acidity or alkalinity of water and is measured on a scale of 0 to 14. The midpoint of 7 is said to be neutral, above which is alkaline and below which is acidic. In spa water, it is very important to maintain a slightly alkaline condition of 7.4 to 7.6. Problems become proportionately severe the further outside of this range the water gets. A low pH will be corrosive to metals in the spa equipment. A high pH will cause minerals to deposit on the interior surface (scaling). In addition, the ability of the sanitation agents to keep the spa clean is severely affected as the pH moves beyond the ideal range. That is why almost all spa water test kits contain a measure for pH as well as sanitizer. Jacuzzi offers products that help you maintain the ideal range. These chemicals are for use in the U.S. only.

14.2 Sanitizing

To destroy bacteria and organic compounds in the spa water, a sanitizer must be used regularly. Chlorine and bromine are the two most popular sanitizers used to date. The "Proclear Mineral Spa Clarifier" designed especially for your hot tub is a beneficial product for water maintenance. Many other additives are available for your spa. Some are necessary to compensate for out-of-balance water; some aid in cosmetic water treatment and others simply alter the feel or smell of the water. Your authorized Jacuzzi dealer can advise you on the use of these additives. When adding spa shock (chlorine or non-chlorine) or pH balancing chemicals activate the jet pump(s) and leave the spa cover open for a minimum of 20 minutes. By doing this you will allow excessive chemical vapors to exit the spa, protecting pillows and plastic knobs from chemical attack.



WARNING: RISK OF PERSONAL INJURY, DROWNING OR ENTRAPMENT!

Never leave your hot tub unattended for any reason while the cover is open and accessible, especially to small children and animals!

CAUTION: RISK OF PERSONAL INJURY OR SPA DAMAGE!

Never add chlorine tablets (trichlor) or acid to your hot tub for any reason! These chemicals may damage components within your hot tub, burn or irritate your skin, create a rash and void the manufacturer warranty for your spa.

14.3 Other Additives

Many other additives are available for your spa. Some are necessary to compensate for out-of-balance water, some aid in cosmetic water treatment and others simply alter the feel or smell of the water. With our chemical products your authorized Jacuzzi dealer can advise you on the use of these additives. Jacuzzi chemicals are for use in the U.S. only.

14.4 CLEARRAY® Water Purification System

Your new hot tub has our water purification system factory installed that will begin disinfecting your water instantly. CLEARRAY Water Purification System is exclusive technology utilizing natural ultraviolet technology to sanitize your water, disinfecting bacteria, viruses, and algae in portable hot tubs. The ultraviolet light otherwise known as UV-C or germicidal light inactivates the microorganisms by disrupting the DNA so that it cannot reproduce and is considered lifeless. The ballast is the power supply for the purification system; it has two LED indicator lights the green indicating incoming power flow and the red indicating the system is properly working. CLEARRAY is standard for all models.

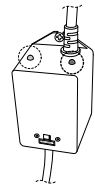

After a year the bulb must be replaced. A message will appear on the LCD display when the time allotted has expired. In order to clear the message, a new UV bulb needs to be installed and the timer must be reset, page 43.



WARNINGS:

- Do not operate the UV-C emitter when it is removed from the appliance enclosure.
- This appliance contains a UV-C emitter.
- Unintended use of the appliance or damage to the housing may result in the escape of dangerous UV-C radiation. UV-C radiation may, even in little doses, cause harm to the eyes and skin.
- Appliances that are obviously damaged must not be operated.
- Read the maintenance instructions before opening the appliance.

14.5 CLEARARRAY® Bulb Replacement and Quartz Tube Maintenance

Important: It is **MANDATORY** that the UV bulb is replaced and the quartz tube be cleaned every 12 months to maintain optimum performance.

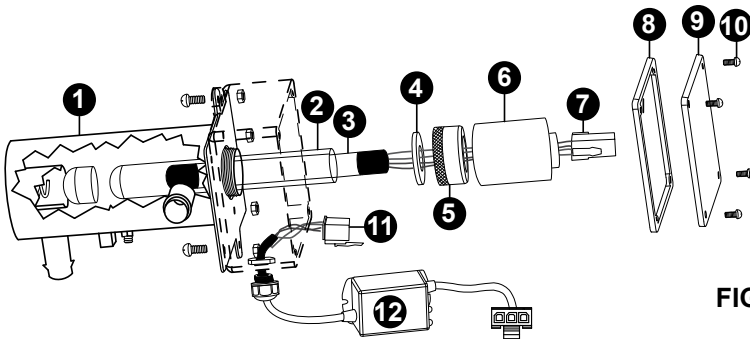

FIGURE 1



DANGER: TURN THE SPA BREAKER TO THE OFF POSITION!



DANGER: DRAIN THE SPA IF YOU ARE REPLACING OR CLEANING THE QUARTZ TUBE!



WARNING: ALLOW LAMP TO COOL DOWN PRIOR TO REMOVING FROM QUARTZ TUBE.



DANGER: NEVER LOOK AT THE LIT BULB. THIS CAN CAUSE SEVERE EYE DAMAGE OR BLINDNESS.

UV bulb replacement and quartz tube maintenance:

Note: Location of CLEARARRAY System and connection may vary by model.

1. Turn the breaker to the spa OFF. DRAIN YOUR SPA.

Note: If you are only replacing the UV bulb then the spa does not have to be drained. You will need to drain it if you are replacing or cleaning the quartz tube.

- Once the UV bulb has cooled off remove the CLEARARRAY System enclosure cover (9) and gasket (8) by removing the four screws (10). This will expose the UV bulb and connections, Figure 2.

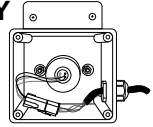

FIGURE 2



DANGER: NEVER REMOVE COVER WITHOUT FIRST TURNING OFF AT POWER SOURCE AND DRAINING THE SPA.

FIGURE 3

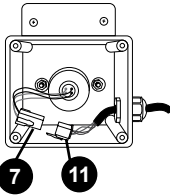

FIGURE 4

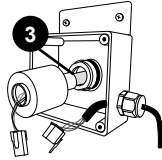

FIGURE 5

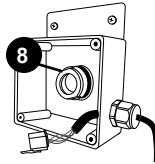
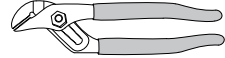

FIGURE 6



- Disconnect UV bulb socket (7) from the power cord socket (11), Figure 3.
- Slowly remove the UV bulb (3) out of the quartz tube, Figure 4.
- Remove the quartz seal compression nut (5) by turning it **counterclockwise**, Figure 5. Use a pair of channel-lock pliers if needed, Figure 6. You will notice that there is a stainless steel compression washer (4) which slides over the quartz tube, save the washer (4) for later use, Figure 7.
- Now you are ready to clean or replace the quartz tube (2). For cleaning the quartz tube (2), follow steps 7 and 8 then proceed from step 9. For replacing quartz tube (2), skip steps 7 and 8 and proceed from step 9.
- Cleaning quartz tube:** Clean the quartz tube by wiping, until clear, using a paper towel or a dry cotton cloth. If needed, a household tub and shower lime removal product can be used.

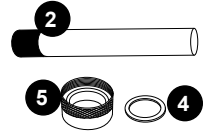

FIGURE 7



WARNING: Do not use abrasive cleaners as they can scratch the quartz tube surface.

- Rinse the quartz tube with clean water to completely remove any cleaning products that were used in step 7.
- Replacing quartz tube:** You will notice that the new quartz tube does not have a black cushion on the domed end as the old quartz tube does. This is normal as the cushion was provided with the original quartz tube to protect it from breakage during transportation. Place the new quartz tube (2) into the water chamber (1) with the domed end first making sure it is inserted and seated inside the quartz end holder. Only a small portion will be exposed when it is seated correctly.
- Reinstall the compression washer (4) over the open end of the quartz tube (2).

11. Reinstall and hand tighten the quartz seal compression nut (5) by turning it **clockwise**.
12. Refill your spa.
13. **System Test 1:** Assure there is no water dripping from the seal compression nut (5). If water is visible, STOP and tighten the compression nut (5) using a pair of channel lock pliers to a maximum of 1/4 turn. If that does not fix the leak, then repeat quartz tube maintenance process from step 1 through step 12. Make sure there is no water leaking before proceeding to step 14.
14. **System Test 2:** Reconnect the CLEARRAY unit to the controller. Turn breaker back ON. Turn on the pump to circulate the water through the CLEARRAY System. Wait for 5 minutes and assure no water is dripping. If water is visible, STOP, fix the leak by repeating quartz tube maintenance process from step 1 through step 13. **Make sure there is no water visible. Turn the pump and breaker OFF BEFORE proceeding to step 15.**
15. Reconnect the UV bulb socket (7) to the power cord socket (11) make sure you use the latex glove provided when handling the UV bulb.



WARNING: DO NOT TOUCH THE NEW UV BULB WITH YOUR BARE HAND. Oil on your skin will cause hot spot on the UV bulb and shorten the life of your UV bulb. Use the provided latex glove to handle the UV bulb.

16. Slide the new UV bulb (3) back inside the quartz tube.
17. Reinstall the black bulb boot (6) back over the quartz seal compression nut (5).
18. Reinstall the enclosure cover (9) with gasket (8) and secure with the screws.
19. Properly dispose of the old UV bulb.



WARNING: This CLEARRAY System includes a UV bulb, which contains mercury. Dispose of the bulb in accordance with disposal laws. See www.lamprecycle.org.

20. Once power is activated you can check the ballast (12), Figure 8, to see if the CLEARRAY System is functioning; it has two LED indicator lights the green indicating incoming power flow and the red indicating the system is properly working.

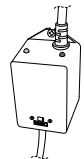



FIGURE 8

15.0 Error/Display Messages

There are a number of unique functions designed into your Jacuzzi spa to protect it from damage and/or to aid in troubleshooting. When an error occurs the spa will notify you by showing the screen below and an error code, Figure 15.0a. Following is a listing of all the possible messages along with their meanings. **Always insist on genuine Jacuzzi replacement parts.**

Note: If you tap  the display will change to Figure 15.0b. The error icon  will remain on the screen as a reminder. If the error is not taken care of or fixed, the error display will reappear in 2 hours, Figure 15.0a.

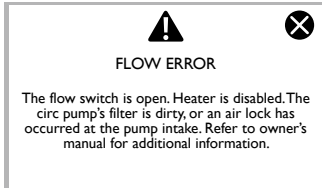

Figure 15.0a

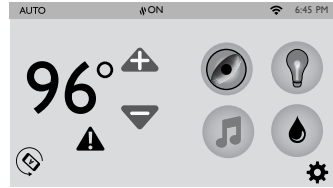



Figure 15.0b



1. **Open Flow Switch:** The flow switch is open. Heater is disabled. The circ pump's filter is dirty, or an air lock has occurred at the pump intake. Refer to owner's manual for additional information.
2. **Closed Flow Switch:** (Heater is deactivated. The filter/circulation may also be deactivated.) The flow switch is malfunctioning closed. Contact your authorized dealer or service organization.
3. **Flow Restriction:** Heater is disabled, check for dirty filter. Consult the owner's manual for additional information.

Note: Make sure to clean the filter(s) and correct proper water level before contacting your dealer or service organization.

4. **Shorted Hi-limit Temp Sensor:** The hi-limit temperature sensor is not functional. Heater is disabled. This must be repaired only by a qualified authorized service organization or service technician.
5. **Open Hi-limit Temp Sensor:** The hi-limit temperature sensor is not functional. Heater is disabled. This must be repaired only by a qualified authorized service organization or service technician.
6. **Shorted Water Temp Sensor:** The temperature sensor is not functional. Heater is disabled. This must be repaired only by a qualified authorized service organization or service technician.
7. **Open Water Temp Sensor:** The temperature sensor is not functional. Heater is disabled. This must be repaired only by a qualified authorized service organization or service technician.

8. Closed Flow Switch on Start-up: Flow switch is non-functional. Closed or shorted flow switch on system start-up (system disabled). Contact your authorized dealer or service organization.
9. Frozen on Start-up: Flow switch is non-functional. Shorted flow switch on system start-up (system disabled) and freeze condition detected. Contact your authorized dealer or service organization.
10. Cool Warning: Spa water is more than 20°F/11°C cooler than the temperature set point, the circulation pump and heater will automatically activate to provide freeze protection. The spa will stay in this mode until the water temperature reaches 15°F/8°C below the set temperature. No corrective action is necessary.
- Note:** The heater icon  will be blinking and the error icon  will be displayed under the temperature.
11. Freeze protection: A potential freeze condition has been detected. No action is required. Jets pump(s) operate until the spa is out of danger. No corrective action is necessary. If condition persists, contact your authorized dealer or service organization.
12. Overheat protection: **DO NOT ENTER THE WATER!** Water temperature is above acceptable limits. Heater is deactivated. Remove spa cover to speed cooling. If condition persists, contact your authorized dealer or service organization.

Note:



- As a safety measure, the red lights of the spa will flash on and off as an indication that the spa is an overheat condition.
- The heater icon  will be blinking and the error icon  will be displayed under the temperature.



**WARNING: RISK OF HYPERTHERMIA (OVER-HEATING)
CAUSING SEVERE INJURY, BURNS, OR WELTS.**

13. Overheat protection: **DO NOT ENTER THE WATER!** Hi-limit temperature above acceptable limits. Heater is deactivated. Remove spa cover to speed cooling. Contact your dealer or service organization.



Note:

- As a safety measure, the red lights of the spa will flash on and off as an indication that the spa is an overheat condition.
- The heater icon  will be blinking and the error icon  will be displayed under the temperature.





**WARNING: RISK OF HYPERTHERMIA (OVER-HEATING)
CAUSING SEVERE INJURY, BURNS, OR WELTS.**

14. Watchdog Protection: **DO NOT ENTER SPA!** Water temperature is above acceptable limits. Your spa is deactivated. Remove spa cover to speed cooling. If condition persists, contact your authorized dealer or service organization.

Note: The heater icon  will be blinking and the error icon  will be displayed under the temperature.



 **WARNING: RISK OF HYPERTHERMIA (OVER-HEATING) CAUSING SEVERE INJURY, BURNS, OR WELTS.**

15. Watchdog Protection: **DO NOT ENTER SPA!** Hi-limit temperature above acceptable limits. Your spa is deactivated. Remove spa cover to speed cooling. Contact your dealer or service organization.



Note: The heater icon  will be blinking and the error icon  will be displayed under the temperature.

 **WARNING: RISK OF HYPERTHERMIA (OVER-HEATING) CAUSING SEVERE INJURY, BURNS, OR WELTS.**

16. Watchdog Freeze Protection: Spa water is below 40°F/4.4°C. Jet pumps operate until the spa is out of danger. Contact your authorized dealer or service organization.

Note: The heater icon  will be blinking and the error icon  will be displayed under the temperature.

17. Controller Overheat Protection: Controller temperature has exceeded acceptable limits. If condition persists, provide shade for equipment side of spa. Contact your authorized dealer or service organization.

Note: The heater icon  will be blinking and the error icon  will be displayed under the temperature.

18. Panel Com Error: The topside controller is having trouble communicating to your spa. Contact your authorized dealer or service organization.

19. Stereo Com Error: The stereo is having trouble communicating to your spa. Contact your authorized dealer or service organization.

20. CLEARARRAY Replacement Reminder
This message will appear when the CLEARARRAY bulb reminder time has expired (Figure 15.0c). The CLEARARRAY bulb must be replaced.

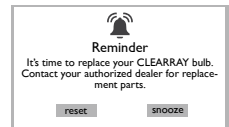

Figure 15.0c

21. ProClarity/ProClear Filter Reminder

This message will appear when the filter reminder time has expired (Figure 15.0d). Remove the ProClarity/Proclear filters and filter/debris bag for cleaning or replacement.

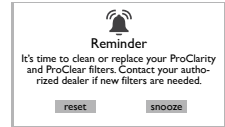

Figure 15.0d

22. ProClarity Depth Filter Reminder

This message will appear when the filter reminder time has expired (Figure 15.0e). The ProClarity Depth filter must be replaced.

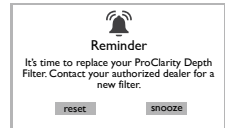

Figure 15.0e

23. Water Refresh Reminder

This message will appear when the “Water Refresh” timer has expired (Figure 15.0f). The water needs to be drained and refilled with fresh water.

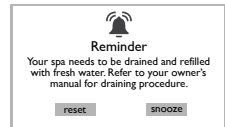





Figure 15.0f

24. Extended Temperature Activated:

The spa is set to go up to 104°F (40°C), but it can be set to reach 106°F (41°C). To access the extended temperature you need press and hold your finger over the temperature reading for about 5 seconds. The temperature reading will start to blink to indicate the system is ready. Tap  to raise the temperature up to 106°F (41°C).

Note: The heater icon  ON will be blinking to indicate that the feature is active.



WARNING: RISK OF HYPERTHERMIA (OVER-HEATING) CAUSING SEVERE INJURY, BURNS, WELTS OR DEATH!
Water temperature in excess of 104°F (40°C) may be injurious to your health.

16.0 Troubleshooting Procedures

In the unlikely event your spa is not working the way you believe it should, please first review all the installation and operating instructions in this manual and check the message on the panel display; second, if you are still not satisfied it is working properly, please follow the appropriate troubleshooting instructions.

PROBLEM	PROCEDURE
<p>NONE OF THE COMPONENTS OPERATE (i.e. pump light)</p>	<p>Check the control panel lights.</p> <ol style="list-style-type: none"> 1. If there are letters or symbols displayed on the screen, refer to the previous Section 15.0 to determine the meaning and action required. 2. If nothing appears on the screen: <ol style="list-style-type: none"> A. Check the household circuit breaker. B. Contact you dealer or authorized service center.
<p>PUMP DOES NOT OPERATE</p>	<p>Activate the "JETS":</p> <ol style="list-style-type: none"> 1. If no sound is detected or if a "buzzing" sound is detected, turn off power to the spa and contact your dealer or service center. 2. If motor operates but no water flows to jets: <ol style="list-style-type: none"> A. Pump may not be properly primed. See instructions below. B. Contact dealer or authorized service center.

Pump Priming Instructions:

1. Turn off power to the spa.
2. Remove the handle from the massage selector supplied by the pump you are priming.
3. Loosen the massage selector's cap slightly (counterclockwise), listening for the air to seep out.
4. Tighten the cap finger-tight, replace the handle and turn the hot tub's power back on.

Note: This method must be used for the jet's pumps because these pumps are not connected to the main filter system in any way.

CAUTION: If freezing conditions exist and pump is not operational, take measures to protect the system from freeze damage. See Section 13.8 titled "Winterizing" (page 57).

- POOR JET ACTION**
1. Make certain the jets pump is turned on.
 2. Check position of massage selectors.
 3. Open air control for selected jet system.
 4. Check for adequate water level.
 5. Check for dirty filter (page 50).
- WATER IS TOO HOT**
1. Reduce thermostat setting.
 2. Switch hot tub to “Economy” mode to turn heater on only during pre-programmed time (page 40).
 3. Make sure the pumps are turned off and not constantly running.
- NO HEAT**
1. Check thermostat setting.
 2. Keep the cover in place while heating.
 3. If heater indicator is displayed, but no temperature increase is experienced after a reasonable period of time, contact your dealer or authorized service center.
- FILTER/CIRCULATION PUMP OFF**
1. Verify filter/circulation pump is programmed to run 8 hours a day (page 40).
 2. Make sure there are no errors preventing the pump from turning on.
 3. Hot tub water is warmer than 95°F (34°C) and 2°F warmer than the set temperature. The “Summer Logic” safety feature has activated. See note on page 41 for details.

Jacuzzi builds the best spas in the industry. Nonetheless, we are always striving to improve the quality and features of our products. Your input as a Jacuzzi spa owner is a cherished part of this process. If you have any comments or suggestions, or if you wish to be informed on any new products for your spa, please write to us.

CONGRATULATIONS on your good taste and welcome to the happiest and most relaxed family in the world!

17.0 Typical Spa Wiring Diagrams

17.1 Wiring diagram for North American 60 Hz Models Only

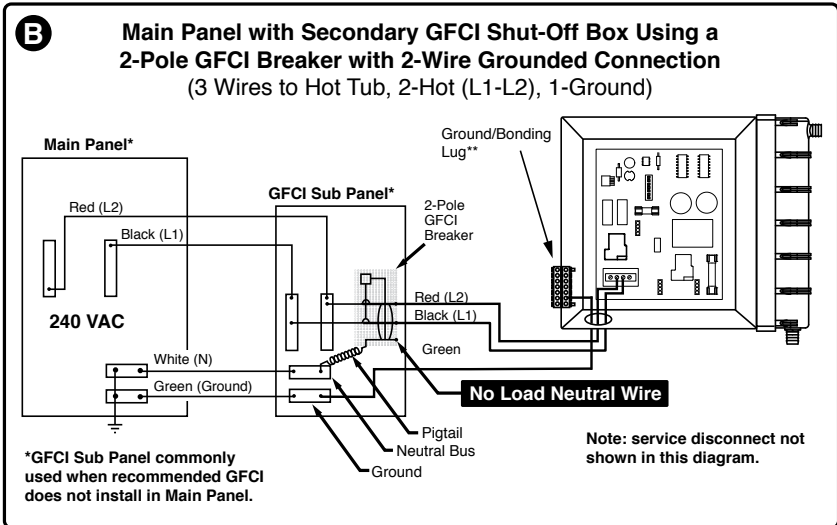
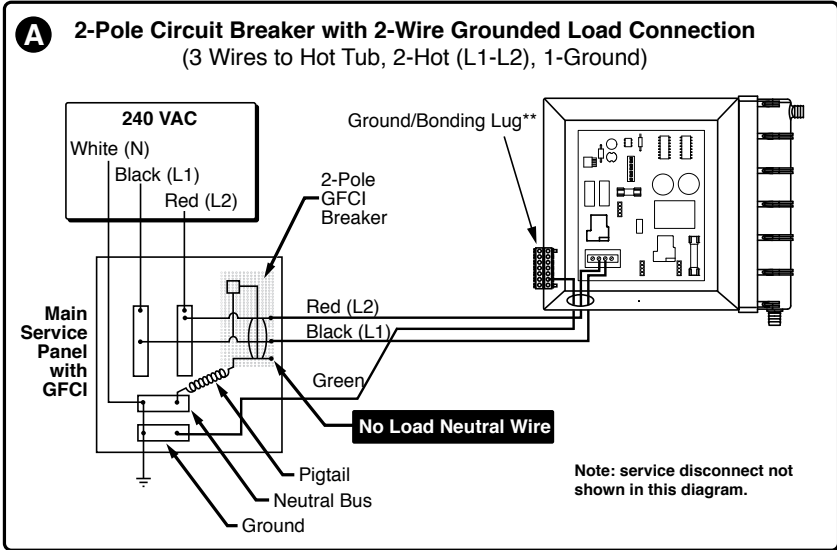

18.0 Circuit Board Wiring Diagrams

18.1 Domestic 60Hz Wiring Diagram

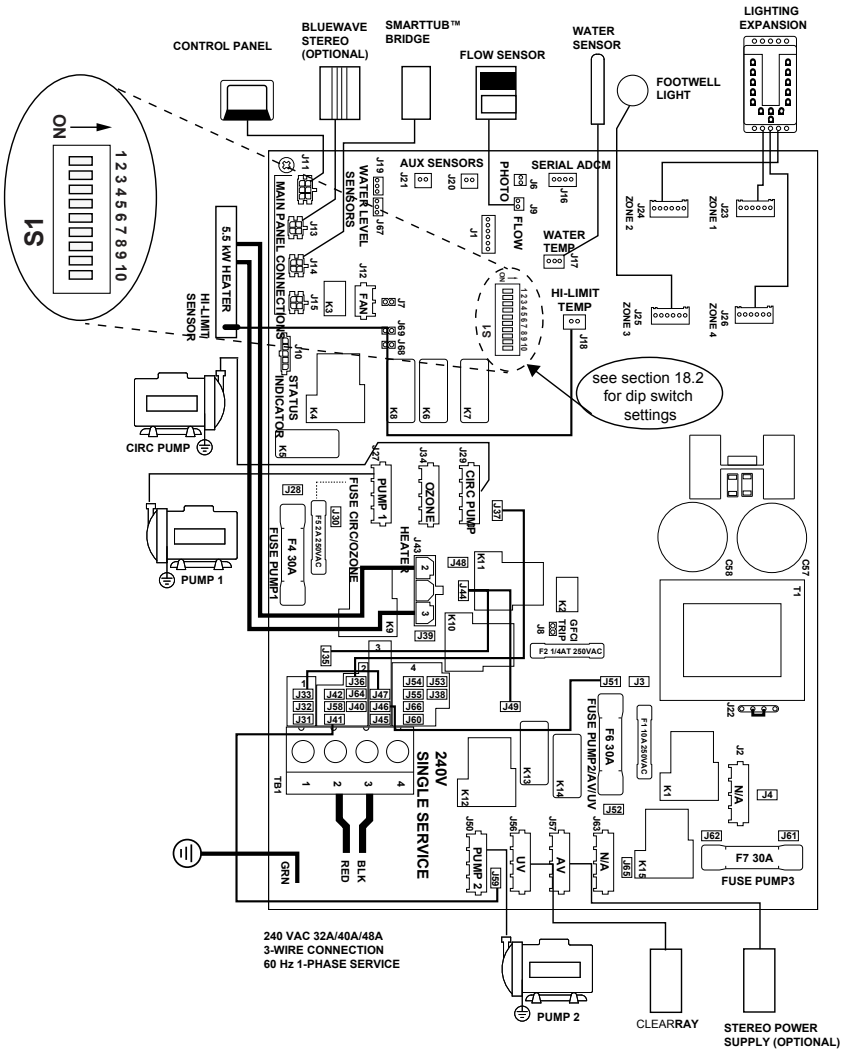

18.2 Dip Switch Settings

The dip switches are at the S1 location on the board.

A. Switch settings for Domestic 60Hz Models

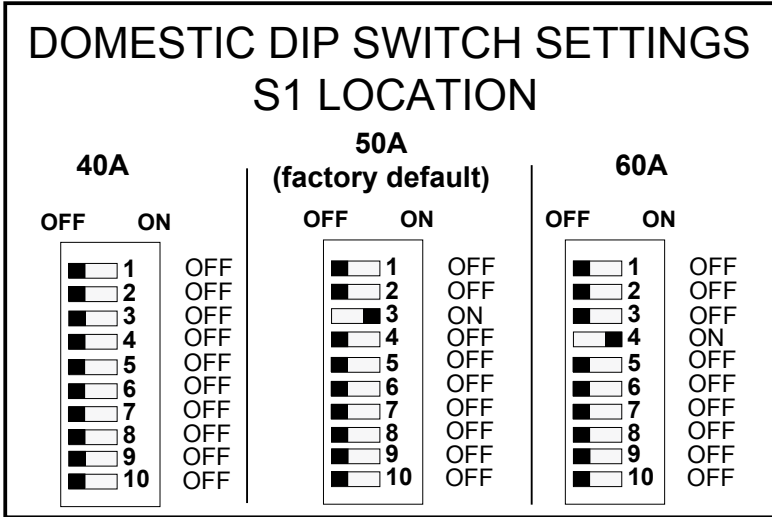

BREAKER	DIP SWITCH NUMBER									
	1	2	3	4	5	6	7	8	9	10
40A	OFF	OFF	OFF	OFF	OFF	OFF	OFF	OFF	OFF	OFF
50A*	OFF	OFF	ON	OFF	OFF	OFF	OFF	OFF	OFF	OFF
60A	OFF	OFF	OFF	ON	OFF	OFF	OFF	OFF	OFF	OFF

*50A is the factory default setting