



S W I M S P A
C O L L E C T I O N

19 ft. / 5.59 m.
POWERPRO™
2021 SWIM SPA
INSTALLATION
GUIDE



CAUTION: THIS GUIDE IS FOR REFERENCE ONLY!

All installations must follow local electrical and building codes. Please consult your local business and planning division for your codes in your area.

JACUZZI™ SWIM SPAS WILL NOT BE RESPONSIBLE FOR ANY ERRORS IN INSTALLATIONS OR CODE INFRACTIONS.

EFFECTIVE DATE: February 1, 2021 (supersedes all others)

2021 19FT. / 5.59 M JACUZZI® POWERPRO™

INSTALLATION MANUAL TABLE OF CONTENTS:

1. Types of installs	Page 1	Cross Section Side View of 2021 19ft. / 5.59 m Jacuzzi® PowerPro™ Swim Spa Install Inground	Page 15-16
1.1 Free Standing with Cabinet above ground			
1.2 Free Standing in Deck with or without cabinet			
1.3 Below Grade Indoor		5.7 Service Access	Page 17
1.4 Below Grade Outdoor		5.8 Water Test	
2. Model, Specifications and Electrical	Page 2	5.9 Overall Support	
2.1 Model and Series		5.10 Insulation	
Shell Dimensions and Weights		5.11 Set Up and Assembly	
2.2 Electrical Specifications	Page 4	5.12 Equipment Protection	
2.3 Wiring Size		6. Serviceability, Accessibility and Protection	Page 19
2.4 GFCI Installations for North America	Page 5	6.1 Equipment Protection	
2.4 RCD Installations for Europe	Page 6	6.2 Serviceability	
3. Delivery and Handling Considerations	Page 7	6.3 Rodent Protection	
3.1 Retailer Delivery		7. Filling and Draining	Page 20
3.2 Direct Deliveries		7.1 General Considerations	
3.3 Crane Deliveries		7.2 Indoor Installations	
3.4 Fork Lift Deliveries		7.3 Outdoor Installations	
3.5 Roller Deliveries		8. Auxiliary Heating Options	Page 20
3.6 Warnings		8.1 Gas Heaters	
4. Above Grade (Base of Support)	Page 9	8.2 Other Methods	
4.1 Preparation		8.3 Auxiliary By Pass	
4.2 Concrete		9. Ventilation, Humidity Control, Other Indoor Considerations	Page 21
4.3 Rooftop / Balcony Install		9.1 Humidity Control	
4.4 IMPORTANT: Swim Spa Frame Shim Installation (Applies to All Installations)		9.2 Ventilation	
Cross Section Side View of 2021 19ft. / 5.59 m Jacuzzi® PowerPro™ Swim Spa Install Above Ground	Page 10	9.3 Hardcover	
Topside View of 2021 19ft. / 5.59 m Jacuzzi® PowerPro™ Swim Spa Install Above Ground	Page 11	9.4 Floor drainage	Page 22
5. Below Grade or Partial In Grade Installations	Page 12	10. Hardcover Storage	
5.1 Backfilling Exclusion		10.1 Hardcover	
5.2 Excavation		10.2 Pool Shed	
5.3 Vault/Bunker Specs		11. By Laws and Disclaimer	Page 22
5.4 Base of Support		11.1 Building Code	
5.5 Crawl Space		11.2 Excavation	
5.6 Ground Water		11.3 Recommendations	
Top View of 2021 19ft. / 5.59 m Jacuzzi® PowerPro™ Swim Spa Inground...	Page 13	11.4 Professionals	
Cross Section End View of 2021 19ft. / 5.59 m Jacuzzi® PowerPro™ Swim Spa Full & Partial Inground Installation	Page 14	11.5 Sunlight	
		Notes	Page 24

I. Types of Installations:

I.1 Free Standing with cabinet above ground

This installation refers to a swim spa that is placed on a concrete pad, above ground and with a Jacuzzi® Cabinet. Can be adjacent to a deck or butted up to a deck.



I.2 Free Standing in Deck

This installation refers to a swim spa that is placed on a concrete pad, above ground and with or without a Jacuzzi® cabinet.

This swim spa is surrounded on one or two sides by deck.



I.3 Below Grade Outdoor

This installation refers to a swim spa that is placed on a concrete pad, below grade and without a Jacuzzi® Cabinet. Can be partially or fully recessed in the ground.



I.4 Below Grade Indoor

Indoor installations of a Swim spa must be placed on a concrete pad. Swim spas can be partially or fully recessed in the floor.

2. Model Series, Specification and Electrical



2.1 2021 19FT. / 5.59 M JACUZZI® POWERPRO™ SWIM SPA

DIMENSIONS*

559 cm. x 236 cm. x 134 cm.
(220" x 93" x 52.75")

USABLE SWIM AREA*

376 cm. (143.3")

DRY WEIGHT

1374 kg. (3028 lbs.)

TOTAL FILLED WEIGHT

10,412 kg. / 22,948 lbs.

AVERAGE SPA VOLUME

9,038 L / 2378 US Gals.

NORTH AMERICAN:

PUMP 1

3 HP / 2 SPD / 12 A

PUMP 2

3 HP / 2SPD / 10 A

PUMP 3

3 HP / 2SPD / 10 A

PUMP 4

3 HP / 2SPD / 10 A

EUROPEAN:

PUMP 1

3 HP / 2 SPD / 10 A

PUMP 2

3 HP / 2 SPD / 10 A

PUMP 3

3 HP / 2 SPD / 10 A

PUMP 4

3 HP / 2 SPD / 10 A



2.2 Electrical Specifications

SAFETY COMES FIRST. WHEN INSTALLING & USING ELECTRICAL EQUIPMENT, BASIC SAFETY PRECAUTIONS MUST ALWAYS BE FOLLOWED!

1. READ AND FOLLOW ALL INSTRUCTIONS

2. Electrical installation must be completed by a qualified electrician in accordance with all National, Regional and Local Codes and Regulations in effect at the time of installation.
3. Connect only to a dedicated circuit protected by a class 'A' two-pole ground fault circuit interrupter (GFCI)
4. Use copper conductors only!
5. The swim spa equipment and all electrical plugs, outlets and lights within 1.5m (5ft) of the unit must be G.F.C.I protected. Consult your electrician or local electrical authority for further details.
6. A green colored terminal or a terminal marked "G", "GR", "Ground", or "Grounding" is located inside the supply terminal box or compartment. To reduce the risk of electric shock, this terminal must be connected to the grounding by means provided in the electric supply service panel with a continuous copper wire equivalent in size to the circuit conductors supplying the equipment.
7. At least two lugs marked "BONDING LUGS" are provided on the external surface or on the inside of the supply terminal box or compartment. To reduce the risk of electric shock, connect the local common bonding grid in the area of the swim spa to these terminals with an insulated or bare copper conductor not smaller than No.6 AWG (Canada/Europe) / No.8 AWG (USA).
8. All field installed metal components such as rails, ladders, drains or other similar hardware within 3 m (10 ft) of the swim spa shall be bonded to the equipment grounding bus with copper conductors not smaller than No.6 AWG.

2.3 Wiring Size

Please consult your applicable electrical codes related to the size of the breakers and the wire. Take into consideration the length of the cable and increases required.

IMPORTANT NOTE:

This Guide is for standard installations where the wire run is 15 m (50 ft.) or less. For longer wire runs, consult a qualified electrician.

Power Requirements

Jacuzzi® swim spas are designed to provide optimum performance and flexibility of use when connected to their maximum electrical service. They are configured at the factory. The most common electrical connections are listed below.

NORTH AMERICAN MODELS (60 Hz)	
VOLTAGE	240VAC
MAX CURRENT DRAW	
PowerActive™ Swim Spa	50A
PowerPro™ Swim Spa	60A
Frequency (Hz)	60Hz
Number of wires	4
EUROPEAN MODELS (50 Hz)	
VOLTAGE	230VAC/28A
MAX CURRENT DRAW	
PowerActive™ Swim Spa	28A
PowerPro™ Swim Spa	28A
Frequency (Hz)	50Hz
Number of wires	3

Terminal Block Connections

1. Neutral wire connection (blue)
2. Hot wire connection (brown)
3. Bonding Lug / Grounding Terminal
4. Power wires entrance (Electrical fitting and conduit must be installed)

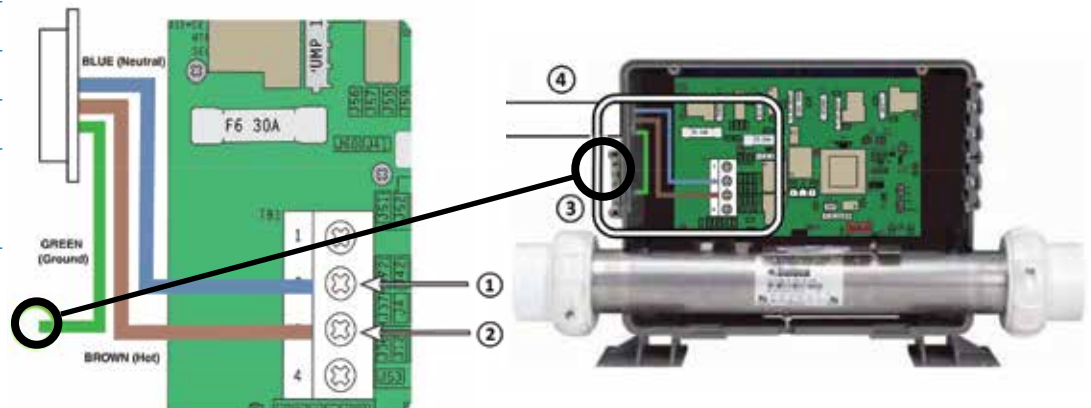

2.4 North American GFCI Installation

Installation of the GFCI - Circuit Breaker, including ampere sizing and selection of conductor size and type, must be performed by a qualified electrician in accordance with the National Electrical Code, or the Canadian Electrical Code, and all Federal, State / Provincial and local codes and regulations in effect at the time of installation. Jacuzzi® highly recommends the use of a new GFCI breaker for all of its products. Older GFCI's may have tripping issues.

TYPICAL SWIM SPA WIRING DIAGRAMS (240VAC - NORTH AMERICA)

240 VOLT 60 HZ SINGLE PHASE GFCI WIRING

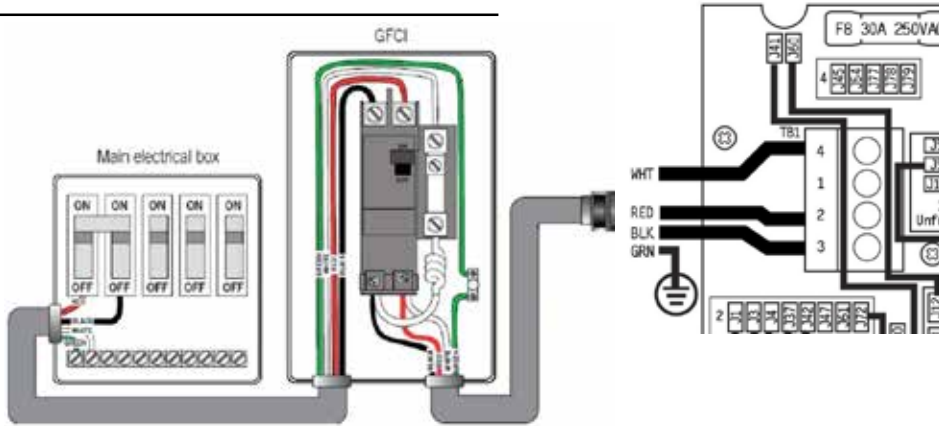

240 VOLT 60 HZ DUAL PHASE GFCI WIRING

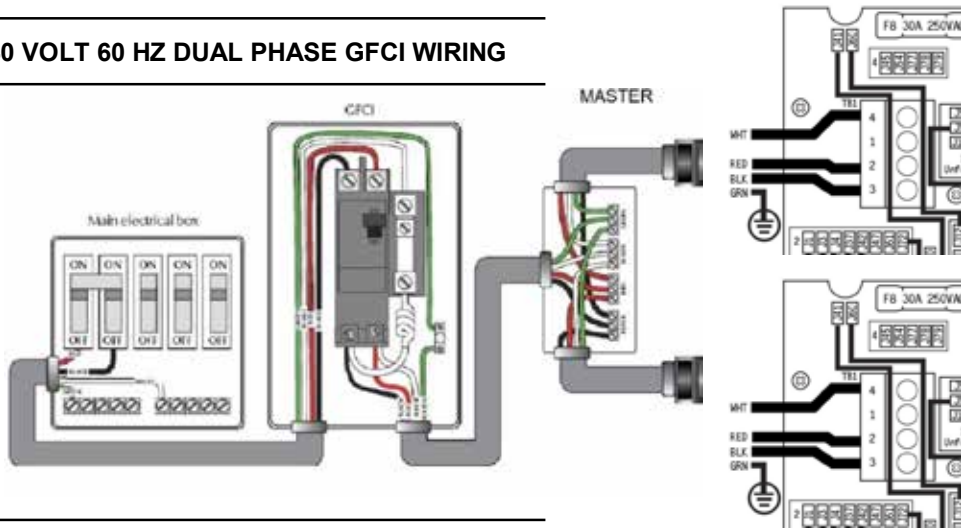

240 VOLT 60 HZ THREE PHASE GFCI WIRING

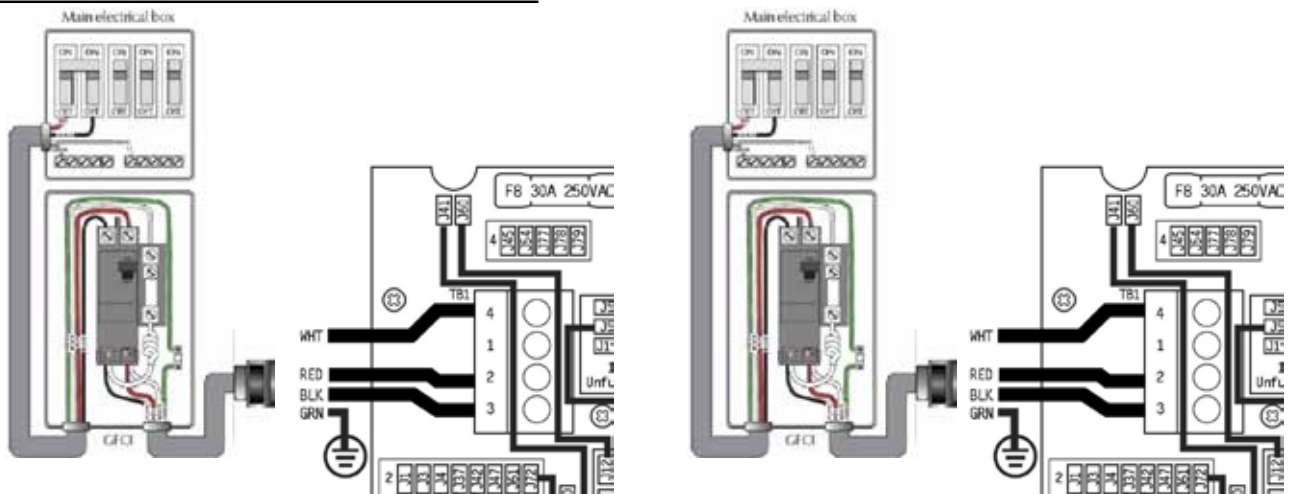

2.4 Typical Swim Spa Wiring Diagrams for European R.C.D. Installation

Important Note:

Installation of the R.C.D. - Circuit Breaker, including ampere sizing, GFCI Security Breaker and selection of conductor size and type, must be performed by a qualified electrician in accordance with National, Regional and Local Codes and Regulations in effect at the time of installation.

TYPICAL SWIM SPA WIRING DIAGRAMS (230VAC- EUROPE)

230 VOLT 50 HZ SINGLE PHASE RCD WIRING

Electrical wiring: European model

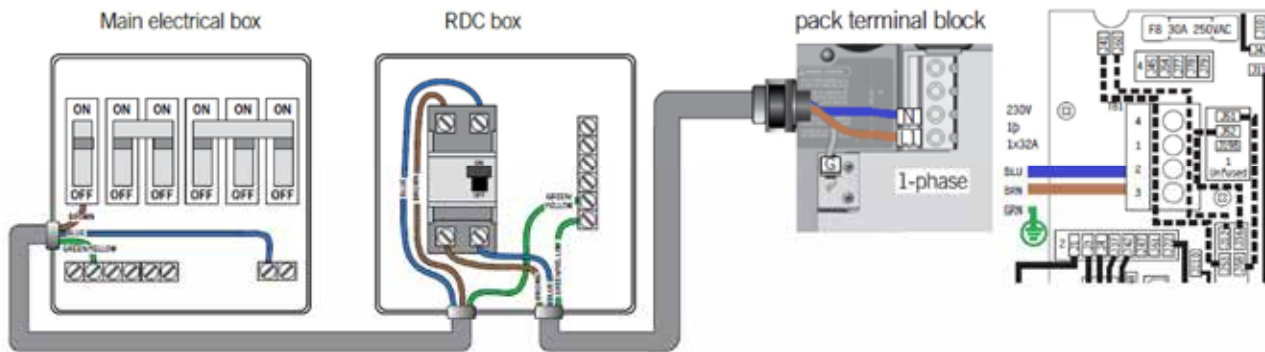

230 VOLT 50 HZ DUAL PHASE RCD WIRING

Electrical wiring: European model

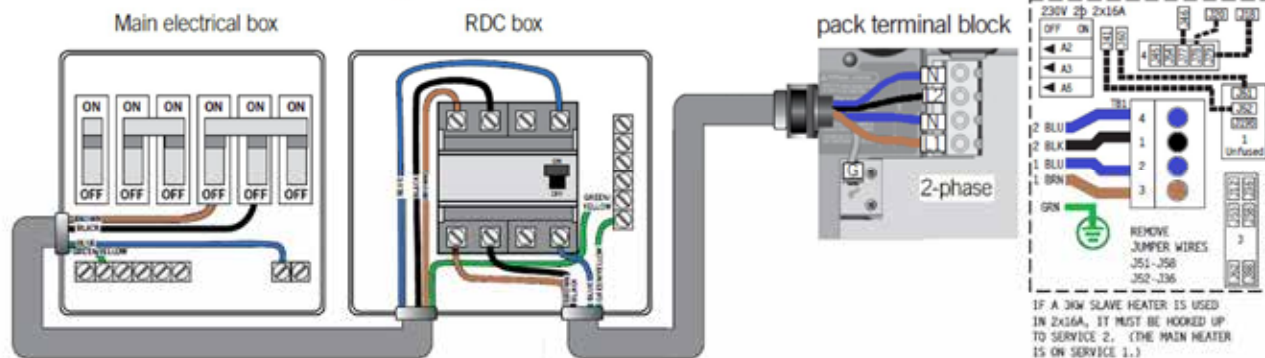

230 VOLT 50 HZ THREE PHASE RCD WIRING

Electrical wiring: European model

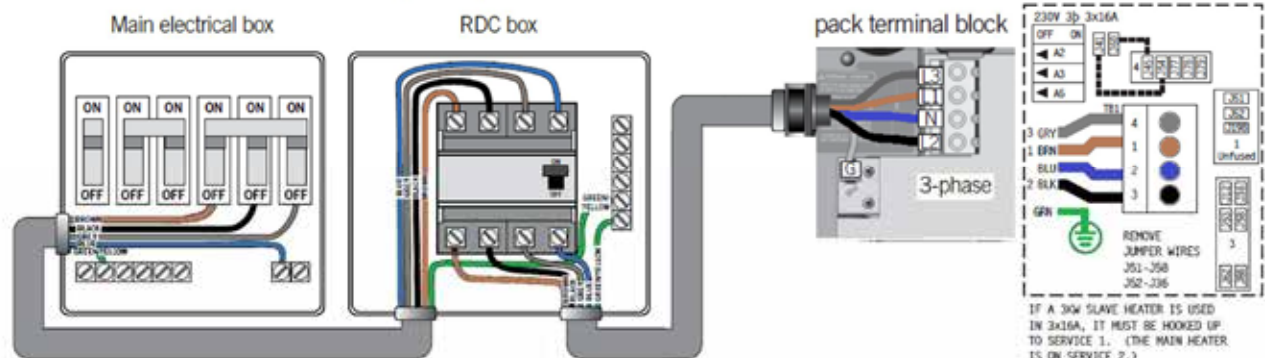

3 Delivery and Handling Considerations

3.1 Retailer Delivery

All Jacuzzi® Swim Spas are shipped with a layer of protective foam wrap, plastic film and cardboard for added protection. Each swim spa is shipped from the factory strapped onto a wood skid. If your swim spa is to be delivered by your local Jacuzzi Swim Spa retailer, it will generally arrive on a flat bed truck or low profile trailer. Typically, the dealer will arrive with the necessary equipment to maneuver the swim spa from the truck. The swim spa can then be lifted by a crane into place.

3.2 Direct Deliveries

Like the retailer delivery, your swim spa will come wrapped and skidded the exact same way, however, your swim spa may arrive on a 14.63 m (48 ft.) or 16.15 m (53 ft.) common carrier closed box trailer. You can arrange the exchange at a local cross docking facility to a flatbed truck. The swim spa can then be lifted by a crane into place.

3.3 Crane Deliveries

Most installations require the use of a crane. When a crane is used for lifting, place the straps under the swim spa, ensuring that the plumbing lines and fittings are not stressed and / or damaged and a spreader is used. The straps should be secured so that they will not slip in any direction and strap spreaders utilized to prevent undue structural side load on the swim spa shell.

3.4 Fork Lift Deliveries

If you are removing the swim spa using a forklift, please make sure to use 2.5-3 m (8 – 10 ft.) extended forks and pick up swim spa at the equipment end.

3.5 Roller Deliveries

Although it is recommended to install your swim spa by crane, it may be pushed along rollers by 10 to 12 able-bodied adults (see image). If rollers are to be utilized, we recommend that at least six 10.16 cm (4") diameter pipes, 2.44 m (8 ft.) long, be placed under the shell to move it across a soft lawn, down a path, etc.

3.6 Warnings!

- Do not move or place the swim spa on its side
- Never lift or handle the swim spa by its plumbing
- the swim spas dry weight is in excess of 1,044 kg (2302 lbs.).
- Please ensure lifting equipment is sufficient for the job. Manually lifting of the swim spa should be done with the proper manpower.
- We strongly recommend the installation to be done by a Jacuzzi® Swim Spa Retailer.

3.1 Retailer Delivery



3.4 Fork Lift Deliveries



3.3 Crane Deliveries



3.5 Roller Deliveries



4 Base Of Support – Load Specifications

4.1 Preparation

Installation of a level concrete pad is mandatory.

Dig out and level the ground 20 - 30 cm (8 -12 in.) below your desired base level. Install 20 -25 cm (8-10 in.) of crushed stone. If there is a possibility that the pad could shift by freezing / thawing ground movement (such as in clay regions, and / or areas with high water tables) concrete footings extending below the frost line are recommended.

4.2 Concrete

Install 10-15 cm (4 - 6 in.) of poured concrete. The concrete support slab must be flat and level in-order to properly level the swim spa during installation. The concrete pad should be slightly larger than the dimensions for the swim spa, but it may be expanded even further for esthetic purposes or to allow more space for walking around the swim spa. Ensure that your concrete pad is capable of supporting 1500 kg/m² (250 lbs. / ft²). If the swim spa is purchased with steps your concrete pad should be made large enough to accommodate the size of the step.

4.3 Second Level / Balcony Installation

You must know the load tolerance and compare it to the weight of the swim spa filled with water and people. When in doubt, a load distribution assessment carried out by an engineer should be consulted, who can guarantee the best location choice. Ensure that your second level balcony is capable of supporting 1500 kg/m² (250 lbs. / ft²). While swimming, the motors and water flow in all swim spas generate vibrations that are directly transferred to the base on which the swim spa is installed. These can therefore be felt in lower levels. In this case, the support area must be properly engineered. Install a floor drain in the event there are any problems with the plumbing to sure that this water has a place to drain.

4.4 IMPORTANT: Swim Spa Frame Shim Installation (Applies to All Installations)

It is mandatory to have full support on all the gussets that are located on side of the swim spa to keep it level and prevent bowing of the swim spa shell. Always make sure that the slab is perfectly flat before having the swim spa installed. You can use a garden hose and spray water on the slab and look for water puddles. If there is formation of puddles, you must re-work the surface, by adding self-leveling concrete or by buffing down the un-even area. The tolerance for the shim under the gusset is 1/8" (.125 inches / 3.175 mm). Anything greater than that may cause structural issues. When the swim spa is installed on the slab locate the stickers or white lines on bottom of the swim spa frame to determine where to install the shim. The shims must be installed right under the gussets (the sticker or white line will appear in the center of the gusset, so it can be used as a guide to align the shim. Note: There are 2 to 4 gussets per side depending on the model.

Simply attempt to insert the shim under the frame by hand and then gently tap on it with a hammer to make sure that it is secure under the frame. If the shim will not slide under by hand then no shim is needed under that gusset. Proceed to the next gusset and repeat this process. Then with a utility knife cut the shim flush to the end of the frame. When all the gussets are sitting properly on the ground, you can start filling the swim spa. Every swim spa will be delivered with a package of shims in case they are needed.

PLEASE NOTE: You may not require any shim, if your slab is perfectly flat. If the frame make perfect contact with the ground, you don't need to add the shim.



Cross Section Side View of 2021 19ft. / 5.59 m Jacuzzi® PowerPro™ Swim Spa - Install Above Ground

SAMPLE

(5.59m) 558.8 cm. (220 inches) Length of the
Jacuzzi® PowerPro™ Swim Spa

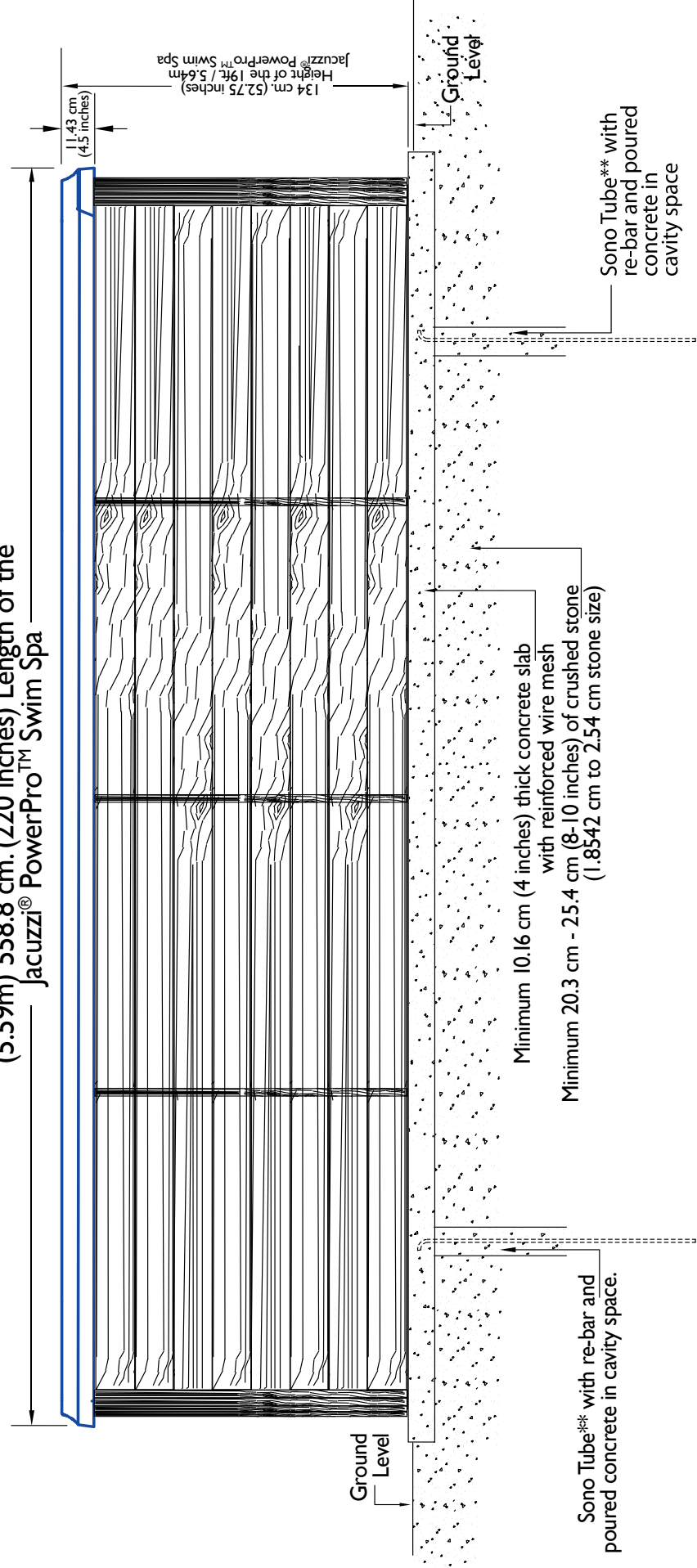

* Jacuzzi® Swim Spas, can not be held liable for the accuracy of this drawing, it is purely provided as a guide only. As each Swim Spa installation has its own set of challenges and variations due to materials used and location of the install.
** Sono Tubes only required in installations that are in regions that experience freezing and thawing.

Cross Section Topside View of the 2021 19ft. / 5.59 m Jacuzzi® PowerPro™ Swim Spa - Install Above Ground

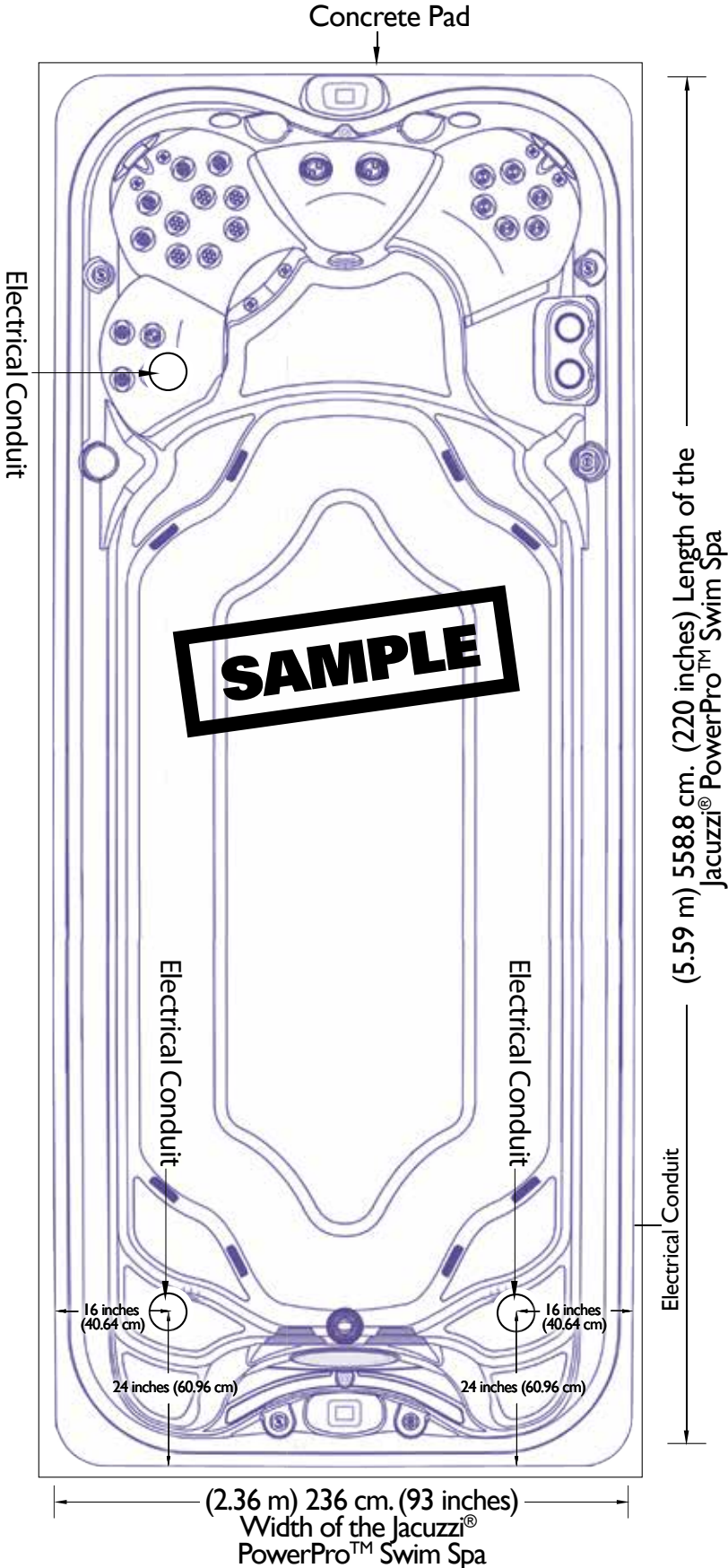

* Jacuzzi® Swim Spas, can not be held liable for the accuracy of this drawing, it is purely provided as a guide only.
As each Swim Spa installation has its own set of challenges and variations due to materials used and location of the install.
** Sono Tubes only required in installations that are in regions that experience freezing and thawing.

5 Below Grade or Partial In Grade Installations Cabinet with Solid State Frame

5.1 Backfilling Exclusion

Jacuzzi® Swim Spas will void any warranty of swim spas that are back-filled.

5.2 Excavation

Call before you dig! Please make sure you have any permits in place that are required from your municipality.

5.3 Vault/Bunker Specifications

When recessing the swim spa all or part way below ground level, a concrete base along with a concrete retaining wall to hold back the earth is required. This forms a Vault or 'bunker', in which the swim spa is placed.

5.4 Base of Support

It is necessary that a concrete base be poured level and reinforced in order to support the swim spa. In addition, if you are in an area that experiences freezing and thawing concrete footings should be added as outlined in section 4 of this guide.

5.5 Crawl Space

It is recommended leaving a 24 in. (61 cm) wide crawl-space around the entire unit to ensure adequate accessibility on the all sides for service access. At the Equipment end it is recommended to have a 3 ft. / 90 cm crawl space for work space.

5.6 Ground Water

The vault will be the lowest part of your backyard and therefore good drainage is essential. A properly designed drain system and sump pump complete with a float switch should be constructed as part of the crib and should be located at the equipment end of the swim spa. This should prevent flood damage from ground water that may enter the crib.



Cross Section Top View of 2021 19ft. / 5.59 m Jacuzzi® PowerPro™ Swim Spa - Inground...

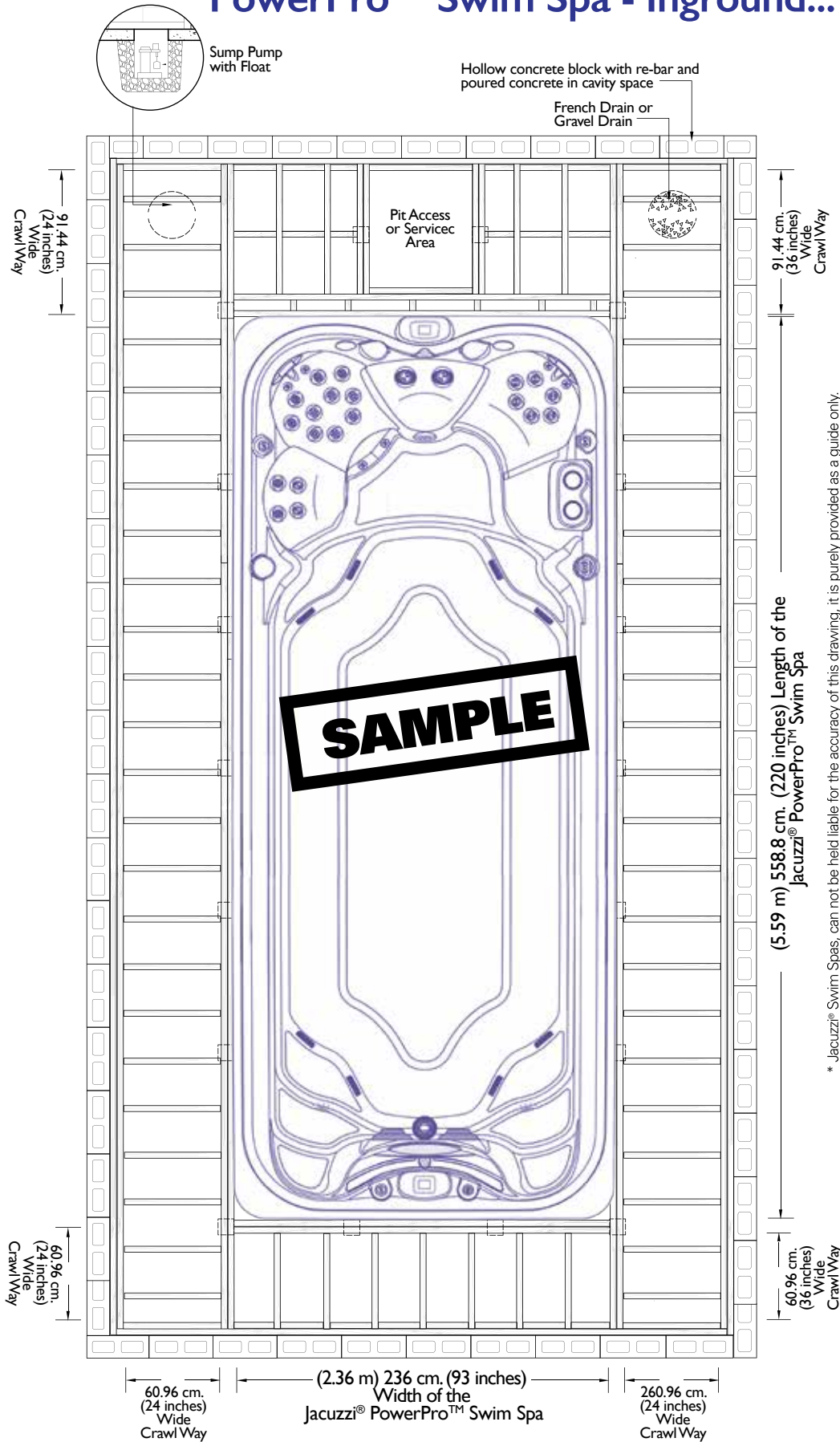

* Jacuzzi® Swim Spas, can not be held liable for the accuracy of this drawing, it is purely provided as a guide only.
 As each Swim Spa installation has its own set of challenges and variations due to materials used and location of the install.
 ** Sono Tubes only required in installations that are in regions that experience freezing and thawing.

Cross Section End View of 2021 19ft. / 5.59 m Jacuzzi® PowerPro™ Swim Spa - Full Inground Installation...

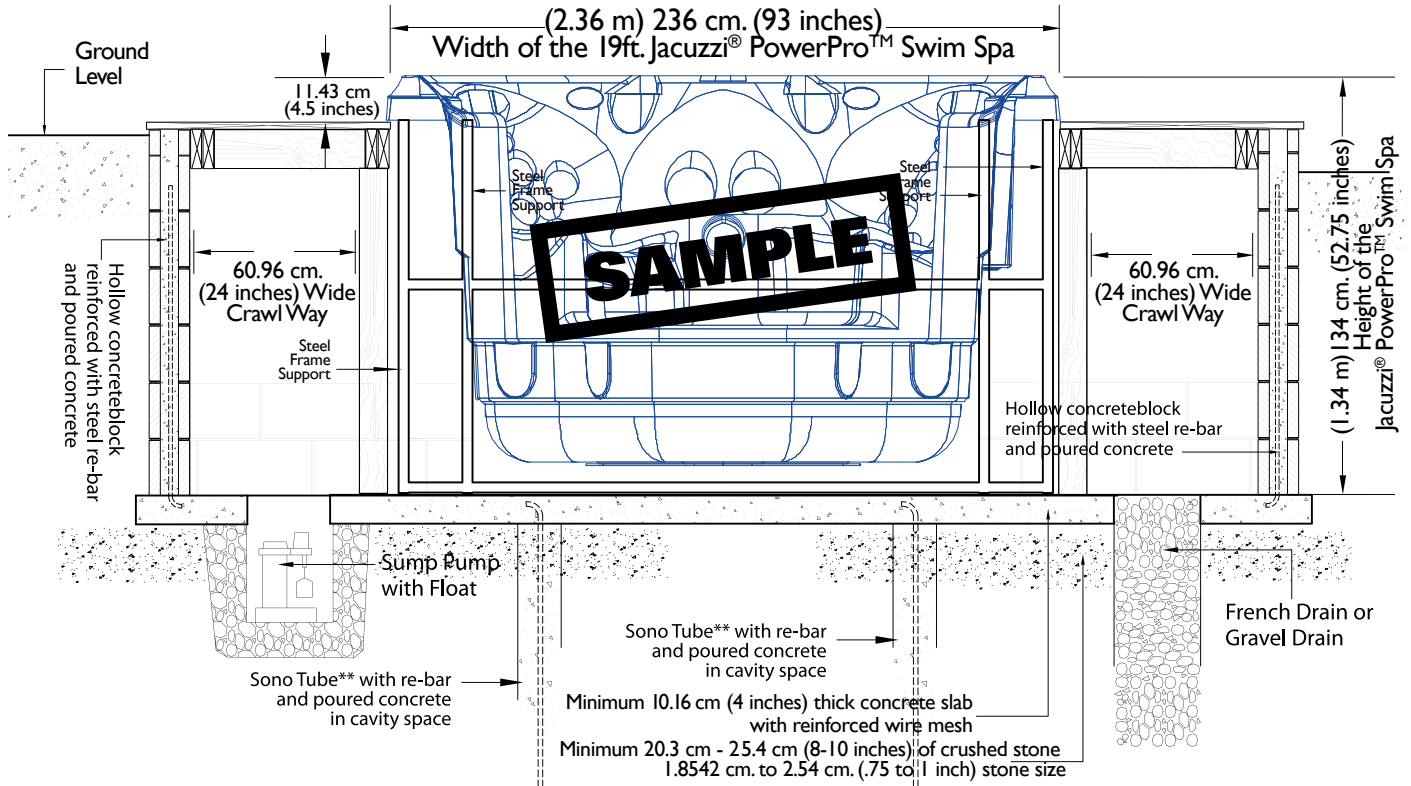

Cross Section End View of 2021 19ft. / 5.59 m Jacuzzi® PowerPro™ Swim Spa - Partial Inground Installation...

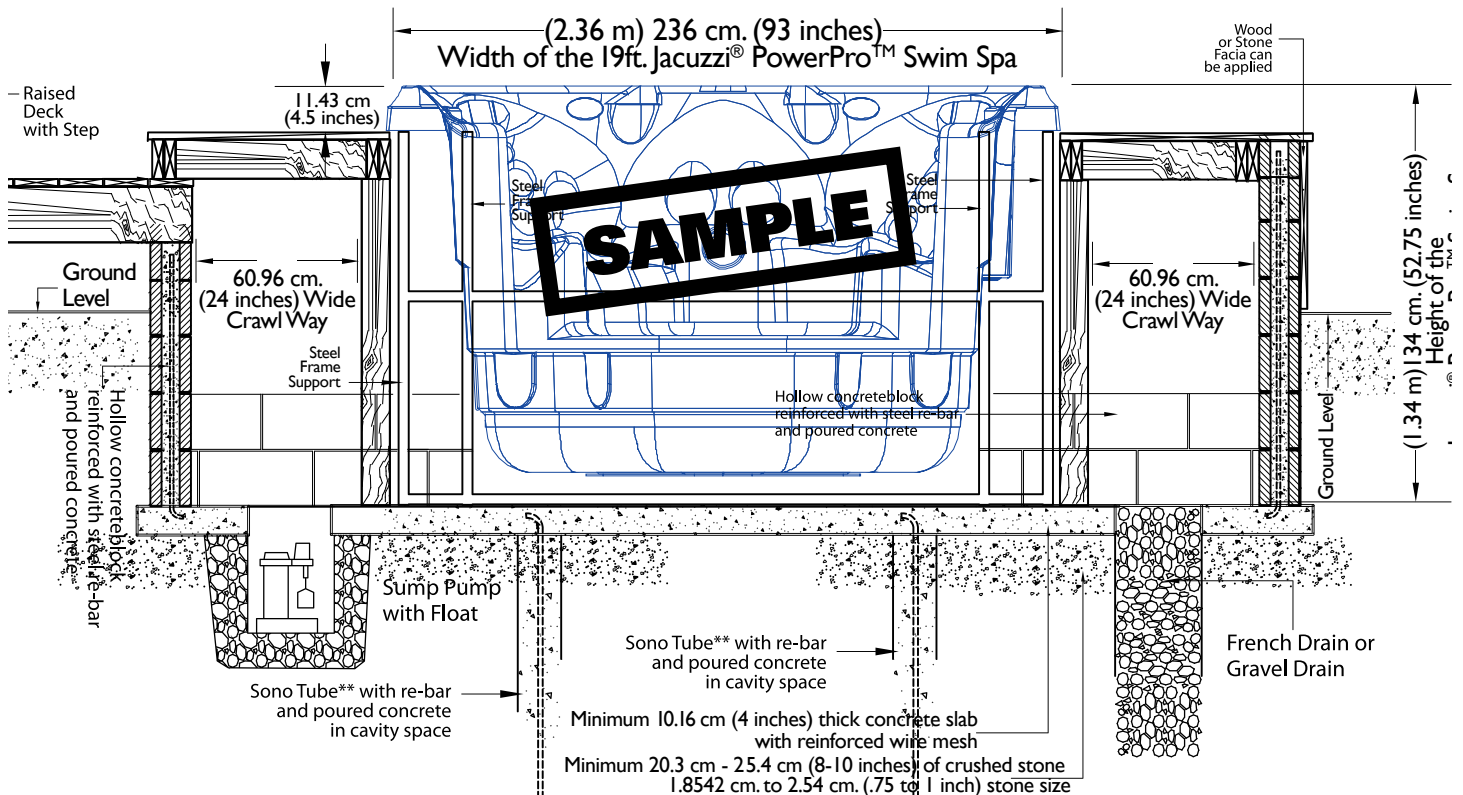

* Jacuzzi® Swim Spas, can not be held liable for the accuracy of this drawing, it is purely provided as a guide only.
As each Swim Spa installation has its own set of challenges and variations due to materials used and location of the install.
** Sono Tubes only required in installations that are in regions that experience freezing and thawing.

Cross Section Side View of 2021 19ft. / 5.64m Jacuzzi® PowerPro™ Swim Spa - Install Inground...

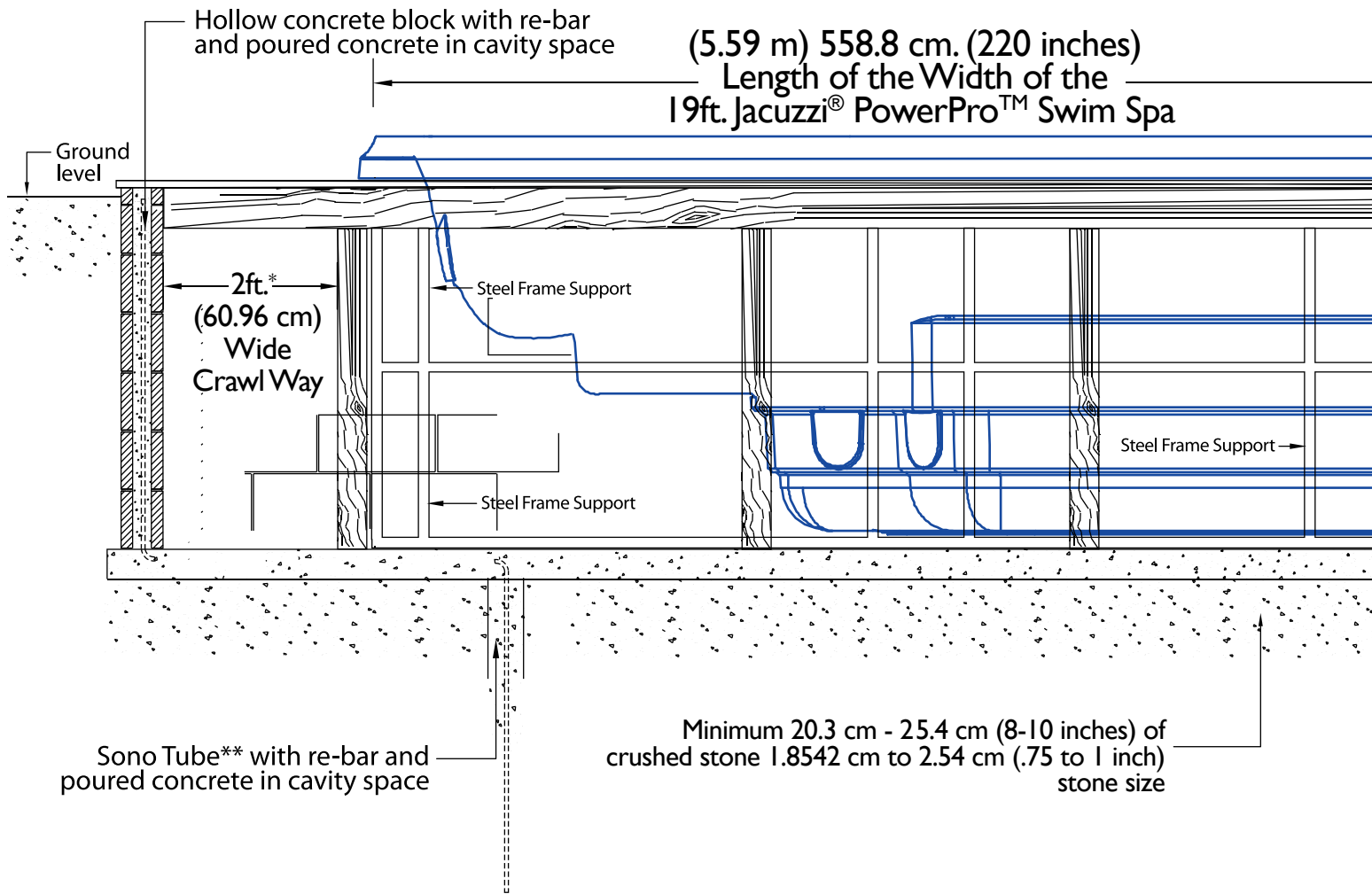

Notes:

* Jacuzzi® Swim Spas, can not be held liable for the accuracy of this drawing, it is purely provided as a guide only.
 As each Swim Spa installation has its own set of challenges and variations due to materials used and location of the install.
 ** Sono Tubes** only required in installations that are in regions that experience freezing and thawing.

SAMPLE

NOTE:
 Support posts for the
 Access Hatch sit between
 the French Drain and
 Sump Pump

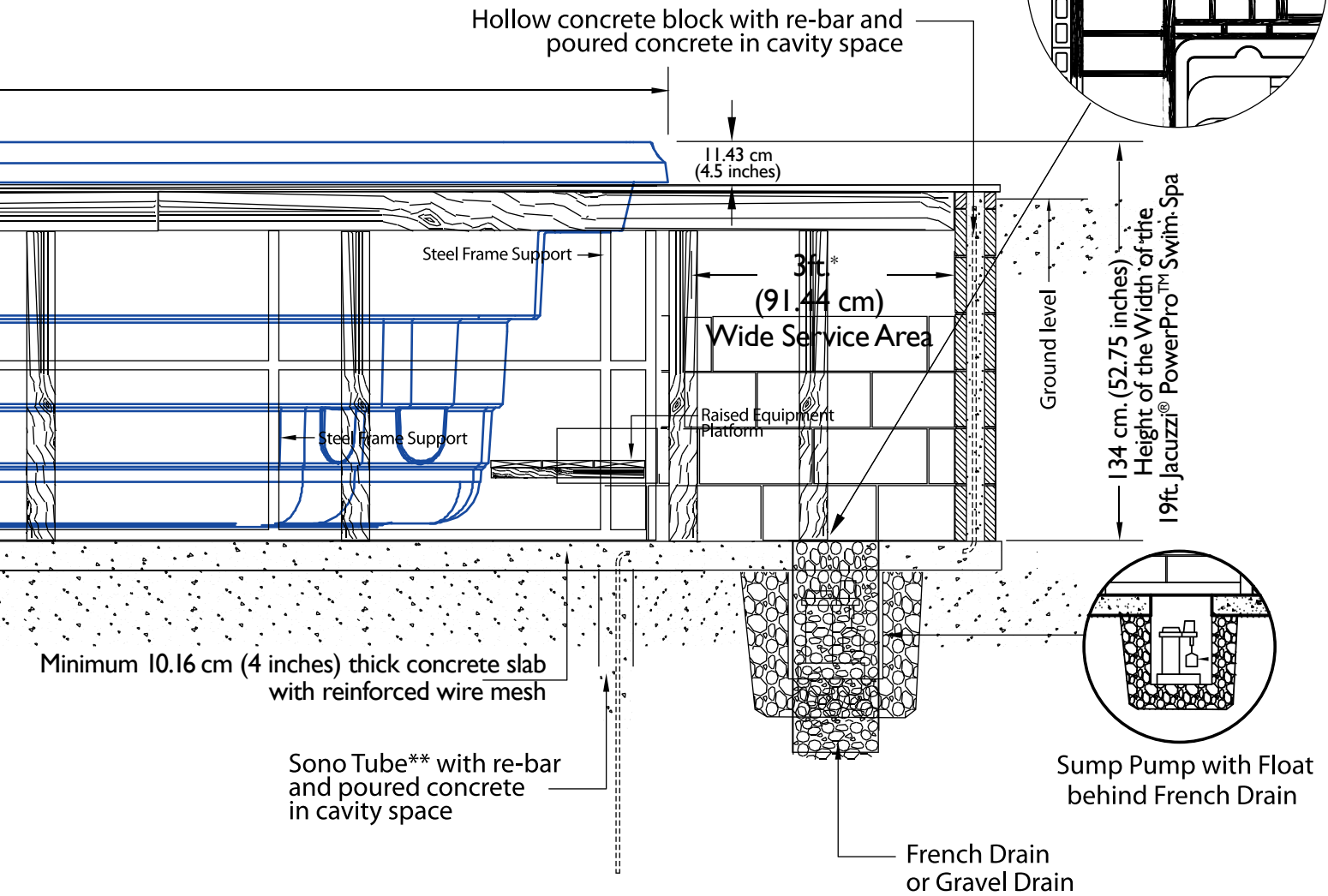

Notes: _____

5 Below Grade or Partial In Grade Installations Cabinet with Solid State Frame (Cont'd...)

5.7 Service Access

Future service must be considered at the time of design and installation. You must be able to access all sides and areas of your swim spa. Difficult access will result in supplemental service labour charges not covered by the factory warranty. Consider easily removable deck materials.

5.8 Water Test

During shipping and handling some of the components may have shifted. Please ensure the swim spa is tested for 48 hours before you prepare the installation of the surrounding/finish deck around your swim spa. Even though all units are tested in our plant, some transport/site handling damage may occur and we suggest you make sure the swim spa is perfectly waterproof before finalizing your installation.

5.9 Overall Support

Your Jacuzzi® Swim Spa is equipped with a factory installed load support substructure, which distributes the weight of the water over the entire foot print area of the swim spa. The supporting floor must be even and level. Although the lip of the swim spa must be supported to ensure it remains level, NEVER SUSPEND a swim spa from a deck or floor by the outer acrylic edge, as this will lead to product damage and/or serious personal injury.

5.10 Insulation

It is important to create a well-insulated vault when installing a swim spa in ground. This can be done a couple of ways:

- 1) Use insulated concrete forms when pouring the walls of the vault. This will accomplish two things, one it will provide the wall support needed to build a deck and two it will give the insulation required to keep the running costs to a minimum.
- 2) After installing the concrete block for the walls of the vault, add Styrofoam Blue insulation or Thermal Shield blanket to the interior walls to create well insulated area.

5.11 Set Up and Assembly

Once your swim spa is set into place, you can adjust the posts for levelling the swim spa and the equipment is already connected.

5.12 Equipment Protection

The equipment must be located in an area where it will remain dry and will not be exposed to rain, snow or ground water. When your swim spa is to be installed above ground, the factory cabinet is designed for both protection, insulation and accessibility. When your swim spa is to be installed fully or partially in the ground, or if you have ordered a swim spa without a cabinet: it is necessary that the equipment be installed in an area that is dry, protected from the elements, has proper ventilation, and is easily accessible for service.



6 Serviceability, Accessibility and Protection

6.1 Equipment Protection

The equipment must be located in an area where it will remain dry and will not be exposed to rain, snow or ground water. When your swim spa is to be installed above ground, the factory cabinet is designed for both protection, insulation and accessibility.

When your swim spa is to be installed fully or partially in the ground, or if you have ordered a swim spa without a cabinet, it is necessary that the equipment be installed in an area that is dry, protected from the elements, has proper ventilation, and is easily accessible for service.

6.2 Serviceability

Ensure that access to the equipment, and the working area around the equipment, is large enough to accommodate a service person.

6.3 Rodent Protection

For any installation, protection from rodent infestation is imperative. If the swim spa is being installed with a cabinet, as long as your concrete pad is level there should be no need for any further protection against rodents.

However, if the swim spa is being installed in ground without a cabinet it is important to take the precautions required to make sure rodents don't make a home in your vault area. Protect access points and repair if needed.



6.1 Accessibility



6.2 Serviceability

7 Filling and Draining

7.1 General Considerations

- Be sure to check with your local by-laws regarding disposal of waste water from your swim spa.
- Avoid filling with soft or well water.
- Filling through the skimmer is optimal for reducing / eliminating any air locks.

7.2 Indoor installations

There will be water lost in the swim spa due to splash out, hence, you will need to top up the swim spas periodically. When building the room for the swim spa consider plumbing a water tap location nearby to facilitate filling. You will need to drain your swim spa periodically, so please make sure to install a drain in the room that can handle the volume of water in a swim spa.

7.3 Outdoor Installations

Draining and Filling is easy with an outdoor swim spa. Use a garden hose to fill the swim spa and use the hose provided to drain it. Do not plumb a permanent fill or drain line to the swim spa if you are in an area where the temperature drops below freezing.

8 Auxiliary Heating Options

8.1 Gas Heaters

There are a number of different ways to heat your swim spa using the Auxiliary Heating Option, the most common is using a gas heater. The most common size used for our swim spas is 100,000 BTU / 30 KWH .

8.2 Other methods are Propane Heaters, Geothermal Heating and Solar heating.

Please consult your local retailer for more information on these alternative methods to heat your swim spa.

8.3 Auxiliary Bypass Option

Installing the Jacuzzi® option Auxiliary Bypass can help to facilitate any of the above installation options.





9 Humidity-Ventilation Other Indoor Considerations

9.1 Humidity

All swim spas emit quantities of moisture into the surrounding air. In fact, evaporation will increase proportionally with the difference between the temperature of the surrounding air and of the water.

To prevent this from happening, heat the air to more than 26° C / 79F if the swim spa is located inside a dedicated room. This will make bathing more comfortable and will limit evaporation.

9.2 Ventilation

The swim spa room should have a window, and a humidistat controlled exhaust fan for ventilation. Some rooms may require a mechanical air extraction system in order to potentially dehumidify the air during and after swimming. Consult your local building codes.

9.3 Covers

If you decide to purchase the hard cover put it on when you are not using the swim spa. This will reduce evaporation and limit your water heating costs. Use your hard cover as much as possible or purchase a floating summer cover for easier use.

9.4 Floor Drainage

It is very important to install a non-slip surface/tile for your indoor installation as the floors will become very slick with water on it. It is also important to install floor drains around the swim spa to help with the splash out.

9.2 Ventilation



9.3 Hard Cover



9.3 Floating Cover



9.4 Floor Drainage



10 Hard Cover Storage

10.1 Hard Cover

If your swim spa comes with a hard cover, make sure to prepare storage area for when the swim spa is being used. The swim spa cover comes standard in a number of sections that are velcroed together depending on the size.

10.2 Pool Shed

Storing the cover in a pool shed is the most common way to keep the cover safe and out of sight.



10.1 Hard Cover

11 By Laws and Disclaimers

11.1 Building Code

Contact your local building code department to determine if a building permit is necessary and for information on applicable bylaws (distance from property lines, buildings, fencing requirements, etc.)

11.2 Excavation

Prior to any excavation contact your local gas, electric, and cable company to ensure that there are no underground lines.

11.3 Recommendations and Preparation Guidelines

This is an integral part of your order, and it contains the recommendations and guidelines for preparing your work site. It is important that you take the time to carefully read this document in your capacity of Project Manager.

11.4 Professionals

Attention: You must enlist professionals to complete the preparation work, and provide a copy of this document to each of them. This work will be carried out under their sole responsibility. Furthermore, if you plan to use a delegated Project Manager, you must also provide him or her with this document, and we recommend that you ensure its proper care in order to guarantee compliance with the regulations. Of course, we are available to answer all of your questions regarding the installation of your spa. The specifications described in this document are intended for professionals and are for informational purposes only. The Project Manager must consider these specifications while performing the work in accordance with the regulations and standards for the specific model.

11.5 Sunlight

DO NOT leave the swim spa out in the sunlight for extended periods of time with no water. The cabinet may bend slightly if exposed to sunlight for extended periods of time or the acrylic may crack.



10.2 Pool Shed

CAUTION: Covers must be kept on the swim spa at all times when unit is drained or winterized. Direct exposure to sunlight can damage plastic parts and interior space, jets, or any interior components. Damage caused by exposure to sun will not be covered under warranty.





S W I M S P A
C O L L E C T I O N

19 ft. / 5.59 m.
POWERPRO™
2021 SWIM SPA
INSTALLATION
GUIDE



CAUTION: THIS GUIDE IS FOR REFERENCE ONLY!

All installations must follow local electrical and building codes. Please consult your local business and planning division for your codes in your area.

JACUZZI™ SWIM SPAS WILL NOT BE RESPONSIBLE FOR ANY ERRORS IN INSTALLATIONS OR CODE INFRACTIONS.

EFFECTIVE DATE: February 1, 2021 (supersedes all others)